

office hardware

# Raiël Steel

ACCESSORIES & HARDWARE  
FOR THE DESKING SYSTEMS  
TWENTY **18**

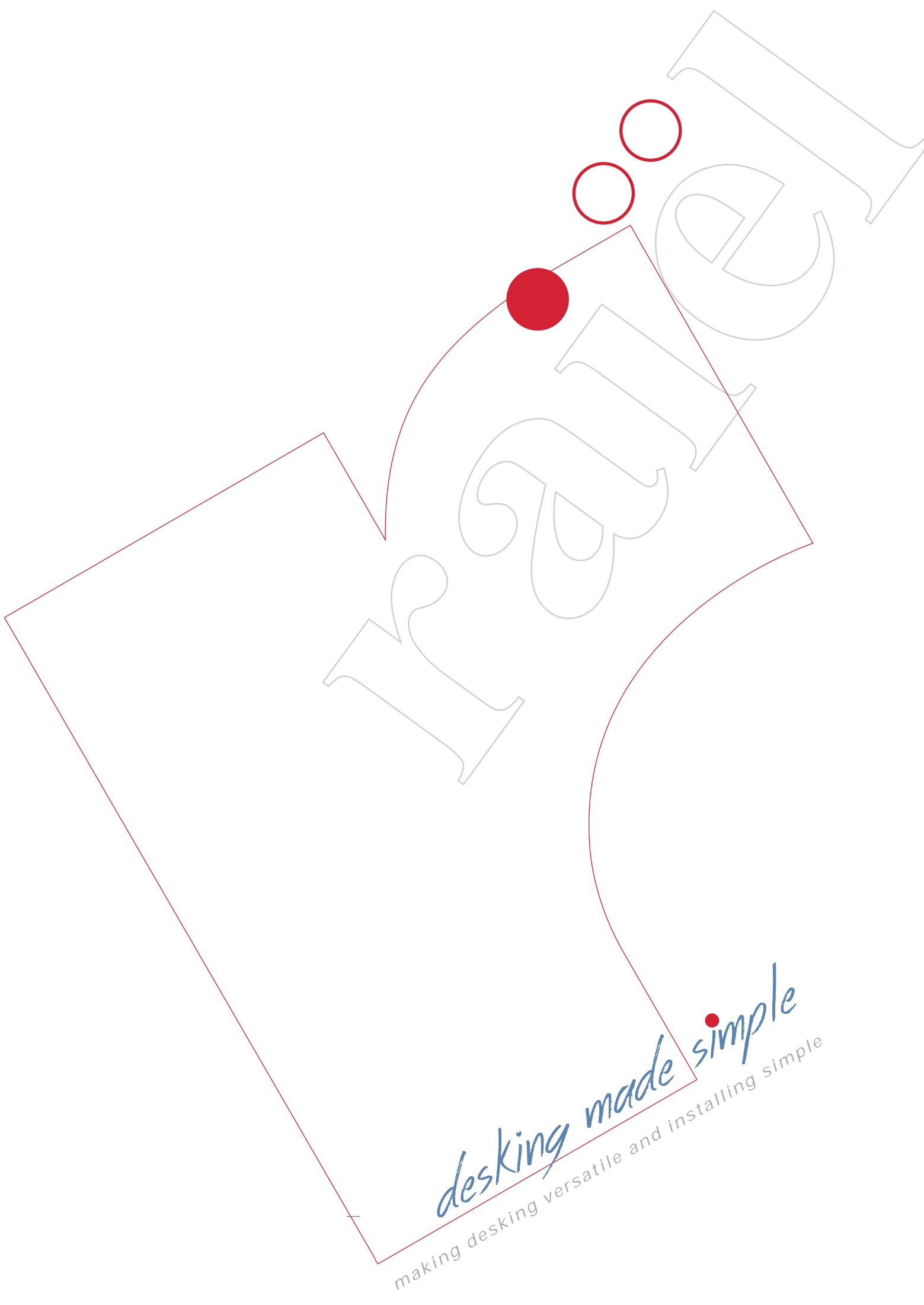



*desking made simple*

making desking versatile and installing simple

# Contents



## HARDWARE ACCESSORIES



LEGS & BAR CONSOLS  
page 05 - 13



CASTORS | page 15 - 24

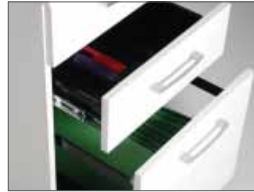

METAL DRAWER BOX  
page 26 - 28



MODESTY PANELS  
page 29 - 31



SCREEN BRACKETS  
page 31 - 33



WIRE/CABLE MANAGEMENT  
page 35 - 40



CPU HOLDERS | page 41

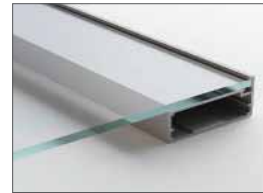

DOOR PROFILES | page 42 - 43



AIRVENTS | page 44



**Malmesbury (head office)**  
tel: 022 482 7400  
**Visit our Showrooms:**  
Maitland | 021 510 2798  
Stikland | 021 944 5900  
Johannesburg | 011 262 2516  
Durban | 031 560 0900  
Port Elizabeth | 041 364 1235

*We reserve the right to change any technical specifications without prior notice.  
Photos may differ from the actual product.*

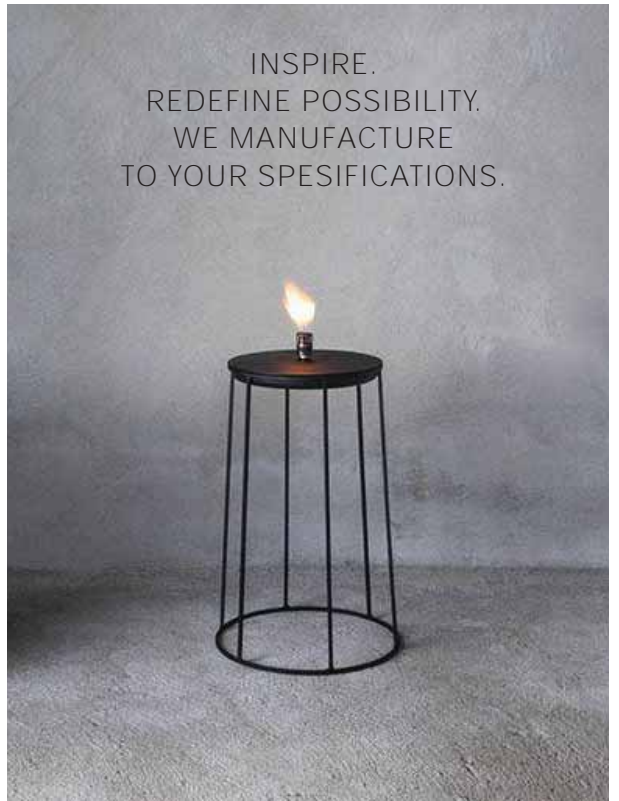



# Legs

## FOR CABINETS MOVABLE FURNITURE & CHAIRS

Raiel (Pty)Ltd supply a variety of legs for office furniture that are specifically designed to conform and enhance any office furniture. Our selection of products is there to help you achieve the most out of your company's potential. Our leg selection is also very much adapted to your needs and specifications regarding height, width and finishes. We offer a selection of styles - traditional, transitional, contemporary, modern and eclectic for different applications. We offer a world of solutions for design, construction and finishing of office and accessories and can manufacture legs to your specifications - MTO will apply.



# Office & Table Legs

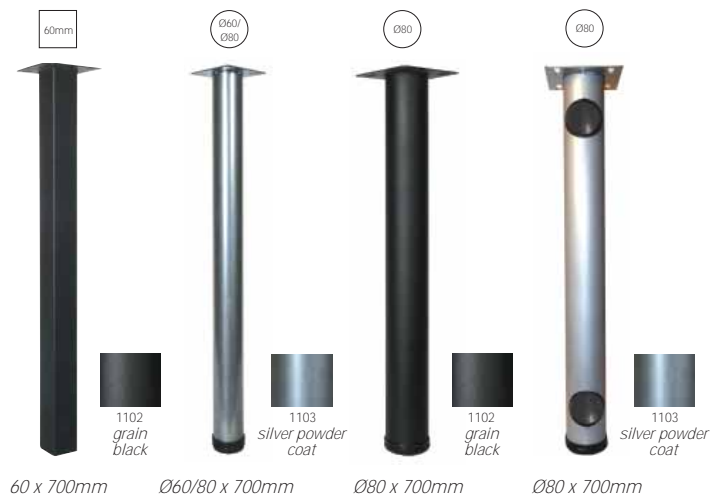

## SQUARE OFFICE LEGS

| ITEM 1585

Material	steel
Size	60 x 700mm
Finish	103 - brushed nickel   RKL338
	1103 - silver powder coat   RKL337
	1102 - grain black   RKL336

## ROUND OFFICE LEGS

| ITEM 1528 | ITEM 1527

Material	steel	Ø60 x 700mm	Ø80 x 700mm
Size			
Finish	103 - brushed nickel	RKL388	RKL314
	1103 - silver powder coat	RKL389	RKL312
	1102 - grain black	RKL390	RKL313
	1101 - grain white	RKL391	

## RETICULATED OFFICE LEGS

| ITEM 1845

Material	steel
Size	Ø80x700mm (the holes are Ø60mm)
Finish	1103 - silver powder coat   RKL497
	1102 - grain black   RKL498



## TAPERED OFFICE LEGS

| ITEM 1529

Material	steel
Size	Ø50 x 700mm
Finish	103 - brushed nickel   RKL317
	1103 - silver powder coat   RKL315
	1102 - grain black   RKL316
	1101 - grain white   RKL392

## ANGLED TAPERED OFFICE LEGS

| ITEM 1586

Material	steel
Size	Ø50 x 700mm
Finish	103 - brushed nickel   RKL341
	1103 - silver powder coat   RKL340
	1102 - grain black   RKL339



## HEIGHT ADJUSTABLE LEGS

| ITEM 655

Material	steel
Size	Ø60 x 710-1100mm
Finish	102 - matt chrome   RKL488
	1103 - silver powder coat   RKL489

## FOLD DOWN LEGS

| ITEM 653

Material	steel
Size	Ø50 x 710mm
Finish	102 - matt chrome   RKL486
	1103 - silver powder coat   RKL487

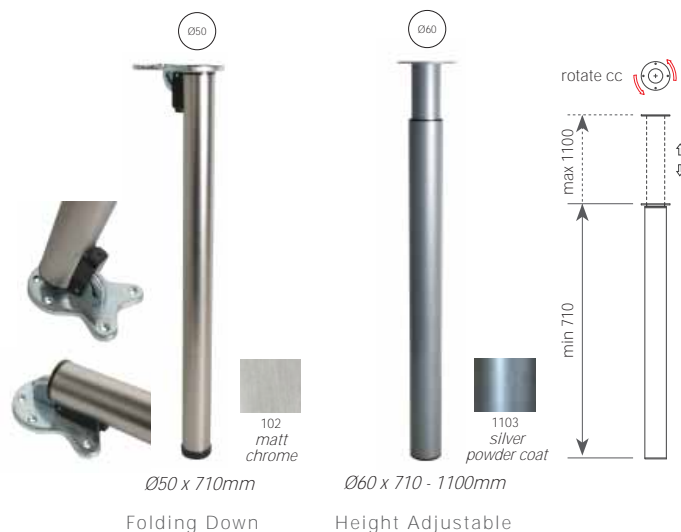

# Fixing Hardware

FOR LEG AND BRACKET

In order to fasten the top plates to tables, it is advised to use, either a M6 x 15mm or M8 x 15mm bolt, and the correct length rubber nuts, be used according to your top thickness.

## Bolt for Legs



M8 x 15mm RIH1836  
M6 x 15mm RIH1835

## Rubber Nuts



M6 x 10mm RIH1446  
M8 x 13mm RIH1834  
M6 x 13mm RIH1453  
M6 x 17mm RIH1447  
M6 x 20mm RIH1445  
M8 x 20mm RIH1448

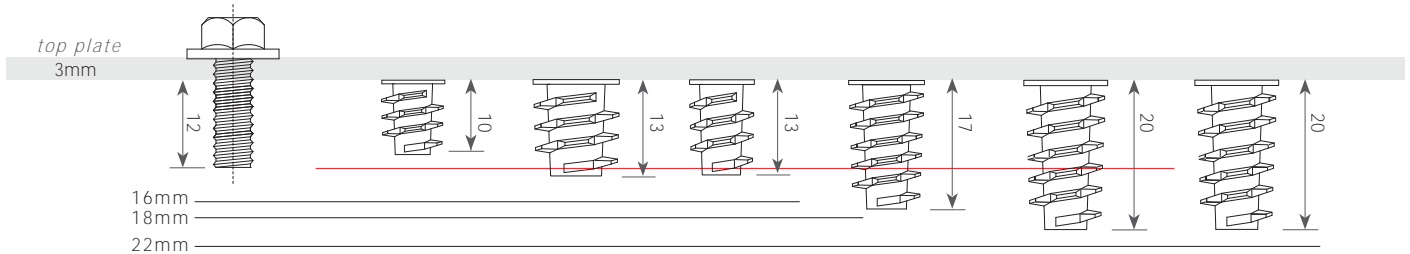

- for further technical information refer to [page 76](#).
- all our rubber nuts have a shoulder on top of the nut, if you need the nut to sit flush to the base, a second countersunk hole will need to be drilled - this will also prevent the nut's shoulder to break off when trying to fasten the nut flush into the wooden base.
- for drilling information, refer to [page 76](#).

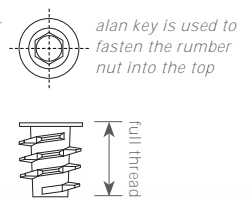
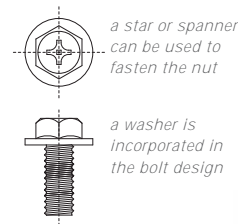
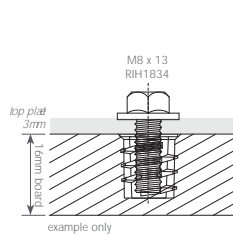
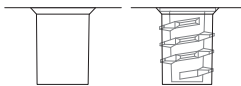

a star or spanner can be used to fasten the nut

an allen key is used to fasten the rubber nut into the top

a washer is incorporated in the bolt design

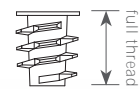

## Made to Order Products (MTO)

We are able to manufacture designs on order, but please bear in mind the following guidelines concerning custom designs:

- designs will have to be approved and may be subject to design change
- minimum order quantities of 100 will apply (MOQ)
- lead times may vary from 4 - 6 weeks



# Coffee Table Legs & Couch Feet

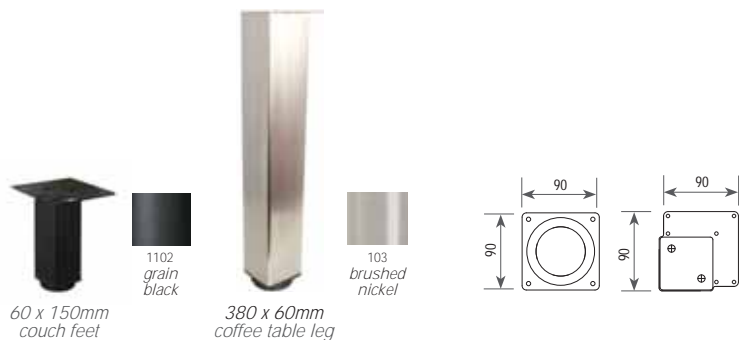

**60MM SQUARE COUCH FEET** | ITEM 1611  
 Material | steel  
 Size | **60 x 150mm**  
 Finish | 103 - brushed nickel | [RKL375](#)  
 | 1103 - silver powder coat | [RKL376](#)  
 | 1102 - grain black | [RKL377](#)

**60MM SQUARE COFFEE TABLE LEGS** | ITEM 1612  
 Material | steel  
 Size | **60 x 380mm**  
 Finish | 103 - brushed nickel | [RKL378](#)  
 | 1103 - silver powder coat | [RKL379](#)  
 | 1102 - grain black | [RKL380](#)

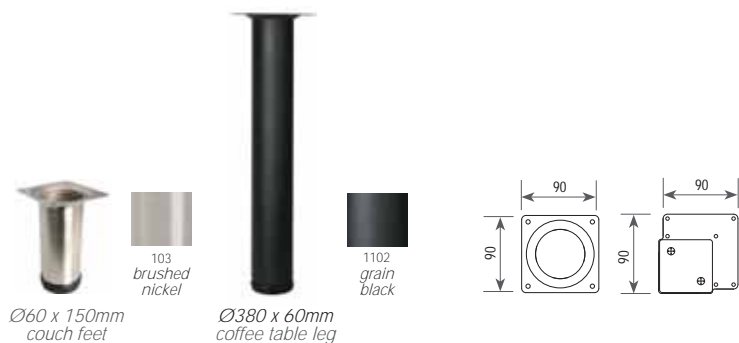

**Ø60MM ROUND COUCH FEET** | ITEM 1613  
 Material | steel  
 Size | **Ø60 x 150mm**  
 Finish | 103 - brushed nickel | [RKL381](#)  
 | 1103 - silver powder coat | [RKL382](#)  
 | 1102 - grain black | [RKL383](#)

**Ø60MM ROUND COFFEE TABLE LEGS** | ITEM 1614  
 Material | steel  
 Size | **Ø60 x 380mm**  
 Finish | 103 - brushed nickel | [RKL384](#)  
 | 1103 - silver powder coat | [RKL385](#)  
 | 1102 - grain black | [RKL386](#)

**Ø50MM ADAM COUCH FEET** | ITEM 1632  
 Material | aluminium with top plate  
 Size | **Ø50 x 50mm**  
 Finish | 103 - brushed nickel | [RKL484](#)

**Ø50MM LA CROIX COUCH FEET** | ITEM 1629  
 Material | aluminium with M10 thread  
 Size | **Ø50 x 50mm**  
 Finish | 103 - brushed nickel | [RKL485](#)

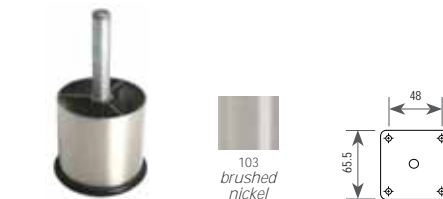
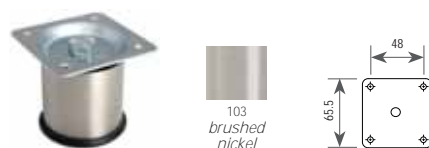

**SQUARE LEG 25X25MM** | ITEM 1062  
 Material | steel  
 Size | **25 x 25mm** | **100mm** | **150mm**  
 Finish | 103 - brushed nickel | [RKL100](#) | [RKL101](#)  
 • weight capacity: 50kg

**ROUND LEG ADJUSTABLE** | ITEM 1065  
 Material | steel  
 Size | **Ø** | **Ø50mm** | **Ø50mm**  
 length | **100mm** | **150mm**  
 Finish | 103 - brushed nickel | [RKL211](#) | [RKL213](#)  
 • weight capacity: | **50kg** | **100kg**



**ROUND LEG** | ITEM 1063  
 Material | steel  
 Size | **Ø30/Ø35 x 100mm** | **Ø30mm** | **Ø35mm**  
 Finish | 103 - brushed nickel | [RKL108](#)  
 | 103 - brushed nickel | [RKL109](#)  
 | 103 - brushed nickel | [RKL110](#)  
 | 103 - brushed nickel | [RKL111](#)  
 • weight capacity: 50kg

**Ø50MM ROUND LEG ADJUSTABLE** | ITEM 1066  
 Material | steel  
 Size | **Ø50 x 100/150mm** | **100mm** | **150mm**  
 Finish | 103 - brushed nickel | [RKL105](#) | [RKL210](#)  
 • weight capacity: 50kg





# Couch Feet

## TAPERED LEG

ITEM 1064

Material	aluminium		
Size	length	100mm	150mm
Finish	103 - brushed nickel	RKL112	RKL113

• weight capacity: 85kg

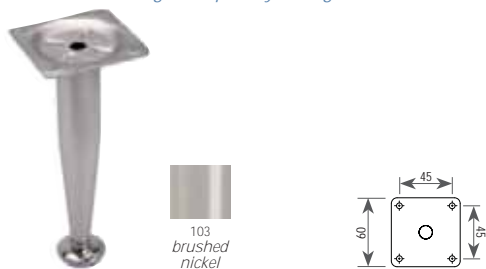

## SQUARE LEG

ITEM 1094

Material	aluminium		
Size	38 x 38mm	80mm	150mm
Finish	103 - brushed nickel	RKL291	RKL292

• weight capacity: 50kg

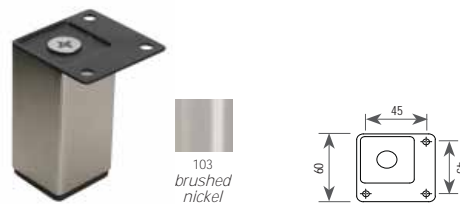

## TAPERED BOTTOM ADJUSTABLE LEG

ITEM 481, 482

Material	aluminium		
Size	length	100mm	150mm
Finish	101 - natural anodised	RKL150	RKL249
	104 - chrome	RKL248	RKL151

• weight capacity: 85kg

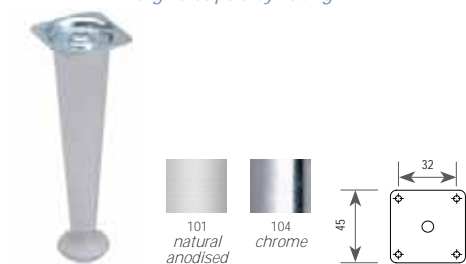

## TAPERED TOP ADJUSTABLE LEG

ITEM 1094

Material	aluminium		
Size	length	100mm	150mm
Finish	101 - natural anodised	RKL148	RKL146
	104 - chrome	RKL149	RKL147

• weight capacity: 85kg

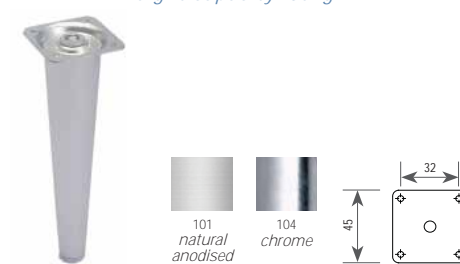

## ROUND LEG COUCH FEET

ITEM 473, 474, 475

Material	aluminium		
Size	concealed base		
Finish	75mm	105mm	145mm
	101 - natural anodised	RKL163	RKL161
	103 - brushed nickel	RKL318	RKL328

small base

Size	85mm	115mm	155mm
Finish	101 - natural anodised	RKL157	RKL156
	103 - brushed nickel	RKL320	RKL332

large base

Size	85mm	115mm	155mm
Finish	101 - natural anodised	RKL169	RKL168
	103 - brushed nickel	RKL329	RKL330

• weight capacity: 85kg



## SQUARE LEG COUCH FEET

ITEM 476, 477, 478

Material	aluminium		
Size	concealed base		
Finish	75mm	105mm	145mm
	101 - natural anodised	RKL154	RKL152
	103 - brushed nickel	RKL321	RKL322

small base

Size	85mm	115mm	155mm
Finish	101 - natural anodised	RKL153	RKL160
	103 - brushed nickel	RKL335	RKL326

large base

Size	85mm	115mm	155mm
Finish	101 - natural anodised	RKL166	RKL165
	103 - brushed nickel	RKL324	RKL334

• weight capacity: 85kg



# Couch Feet



104  
chrome

**SESTO LEG 25** | ITEM 1581  
 Material | steel  
 Size | 130mm | 170mm  
 Finish | 104 - chrome | RKL367 | RKL005  
 • weight capacity: 150kg

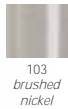

103  
brushed  
nickel



1006  
saddle  
wood

**SESTO LEG 19** | ITEM 1345  
 Material | steel  
 Size | 130mm | 200mm  
 Finish | 103 - brushed nickel | RKL008 | RKL009  
 1006 - saddle wood | RKL010 | RKL011  
 • weight capacity: 80kg

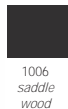

1006  
saddle  
wood

**LAZIO Ø19** | ITEM 1346  
 Material | steel  
 Size | 150mm  
 Finish | 1006 - saddle wood | RKL012  
 • weight capacity: 80kg

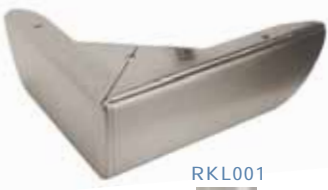

RKL001



103  
brushed  
nickel



RKL281



103  
brushed  
nickel

**TEMPO LEG 120 / 150** | ITEM 1060  
 Material | steel  
 Size | 30mm | 50mm  
 Finish | 103 - brushed nickel | RKL001 | RKL281  
 • weight capacity: 150kg | 250kg



straight



RKL015



103  
brushed  
nickel



angled



RKL018



1006  
saddle  
wood

## **mto** Made to Order Products (MTO)

**NEO LEG STRAIGHT** | ITEM 1348  
 Material | steel  
 Size | 150mm  
 Finish | 103 - brushed nickel | RKL015  
 1006 - saddle wood (MTO) | RKL017  
 • weight capacity: 80kg

**NEO LEG ANGLED** | ITEM 1349  
 Material | steel  
 Size | 150mm  
 Finish | 103 - brushed nickel | RKL016  
 1006 - saddle wood (MTO) | RKL018  
 • weight capacity: 80kg



Made to Order Products  
**mtto**



# Bar Consoles

FOR COUNTERTOPS AND TABLE TOPS



## SQUARE BAR CONSOLE

| ITEM 826

*Material* | aluminium

*Size* | 322mm

*Feature* | Side Mounted

*Finish* | 101 - natural anodised | RKW380



## STRAIGHT BAR CONSOLE

| ITEM 814

*Material* | aluminium

*Size* | Ø50 x 200mm

*Finish* | 103 - brushed nickel | RKW293

102 - matt chrome | RKW294

*Space between consoles should not exceed 600mm to carry weight of 15kg.*



# Bar Consols

Various combinations are possible to create various applications, when selecting the consol components.  
Aluminium available in natural anodised and stainless steel finish.  
NB! All components are sold separately - you choose and create!

Refer to Raiël Catalogue Volume 7, pages 79-81, for the full range, complete product list and specifications of the Bar Consols.

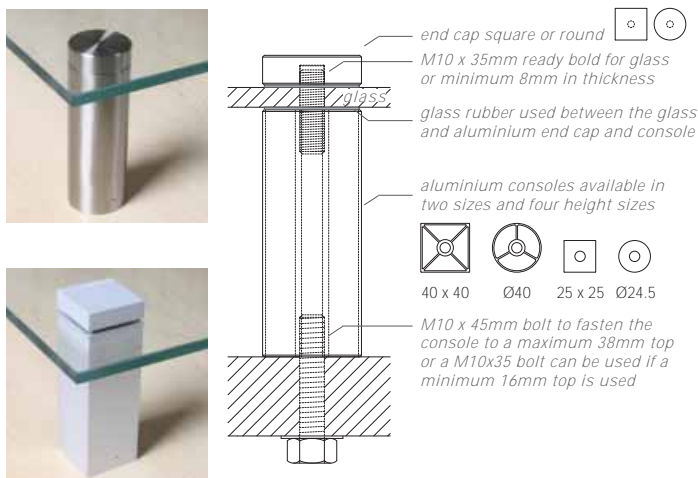

## application 1

A Ø10.5mm hole is drilled through the glass, which is then fastened to the console using a round or square end cap.

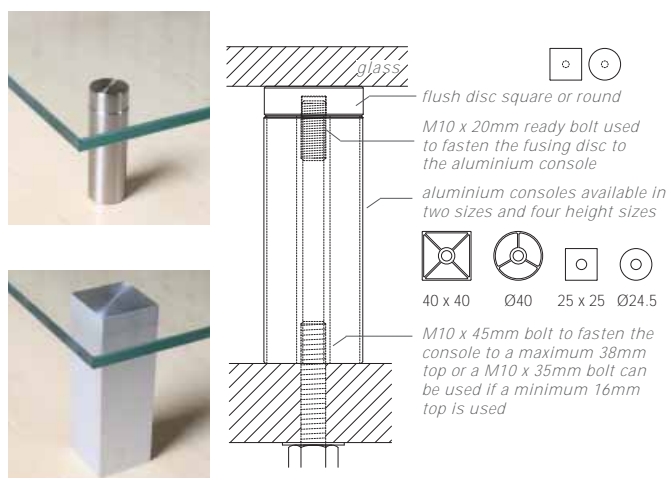

## application 2

A fusing disc is fused to the glass.

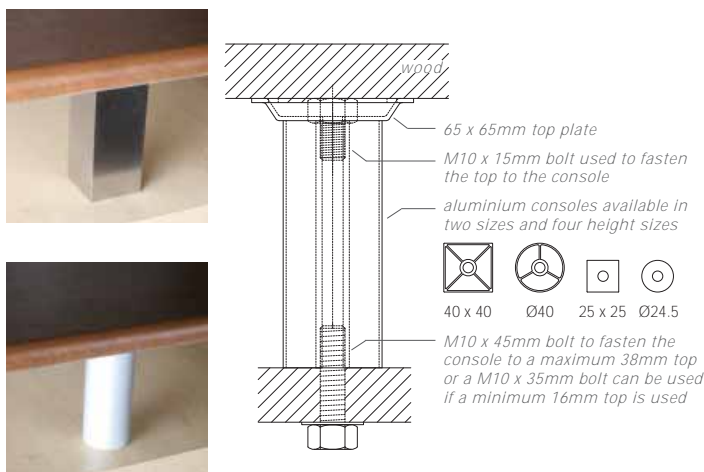

## application 3

The console is fitted to a wooden top.

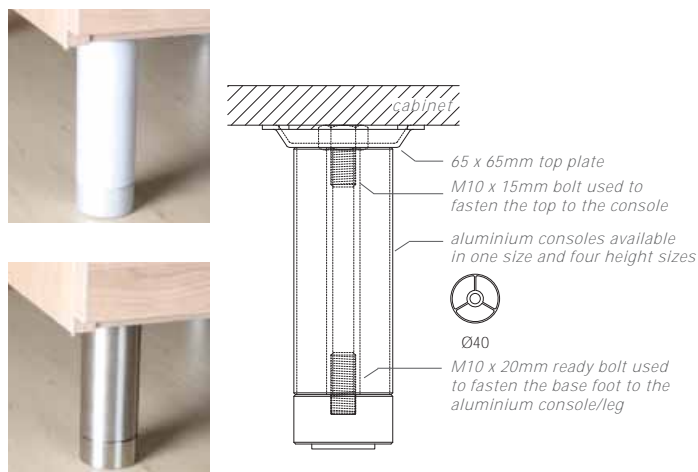

## application 4

The console is fitted as a leg underneath a cabinet.

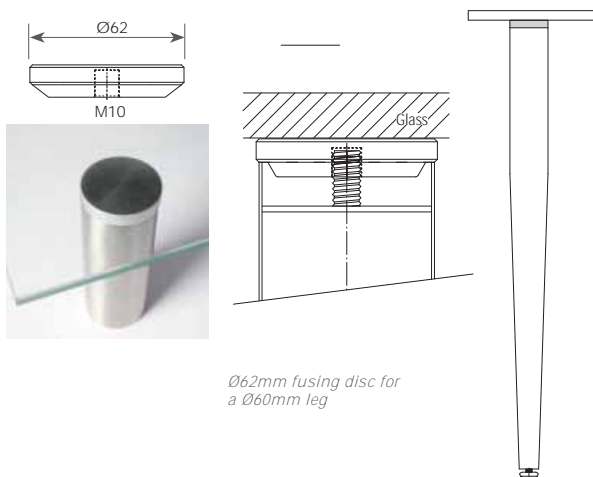

## application 5

Fusing a Ø60mm leg on a glass top using a Ø62mm fusing disc.

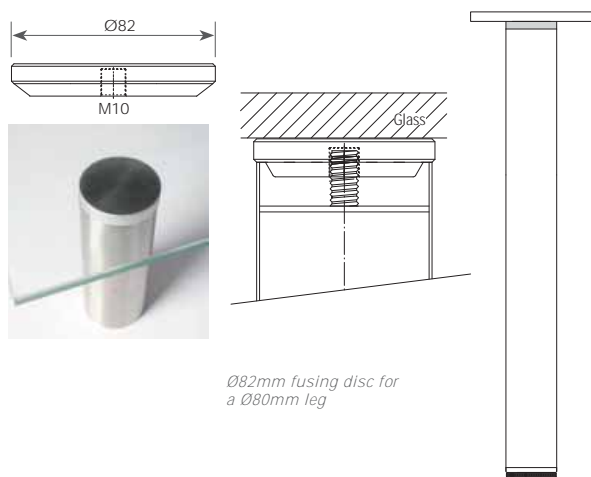

## application 6

Fusing a Ø80mm leg on a glass top using a Ø82mm fusing disc.



EXCITE | INSPIRE | REWARD

Supplier of decorative and hardware solutions  
to the industry for more than 30 years.

VISIT OUR SHOWROOMS

Cape Town | Gauteng | Port Elizabeth | Durban

tel 022 482 7400

[www.raiel.com](http://www.raiel.com)



# Castors

FOR CABINETS MOVABLE  
FURNITURE & CHAIRS



Robby Hardware Products Co was founded in 1992 in Southern China and has a modern factory covering 13.000sqm. We are a professional manufacturer of furniture castors and have a strong reputation for developing new ideas and products. We have 1,500 loyal customers from countries all around the world. All our products comply to the highest quality standards and Robby is audited by TUV to ISO 9110:2015 for the past 10 years. Our investment in the quality department and the procedures we use ensure that our products remain at the highest levels possible.

Just as important to Robby is the development of our products and our Design Manager Jose Vinaroz continually develops cutting edge designs that are very pleasing to look at and designed with strong function in mind. This allows Robby to continually develop our brand to be a leader in our field. Our recent Bola, Frog, Koo, Olym and Laia castors are all examples of us taking new ideas into production castors that are successful and give the company great pride.

This is what makes Robby one of the most famous castor brands in the world.

## HOW THE SYSTEMS WORK

- The Robby series does not only meet the most high quality standards, but with the versatility of this product to choose the necessary types of fixing pins or top plates available, which are indicated with each castor by code.
- Individual castors are available with or without brakes.
- Certain castors also include a \*Smart Brake® with a unique three level locking feature - locked, reverse and free. It can also be provided with the \*Silence System® that blocks out noises while moving the chair and makes the mounting process easier.
- Information on every castor is indicated - height, wheel size, width and the weight capacity.
- Full technical information is available on CD and on Raiel website - [www.raiel.com](http://www.raiel.com)

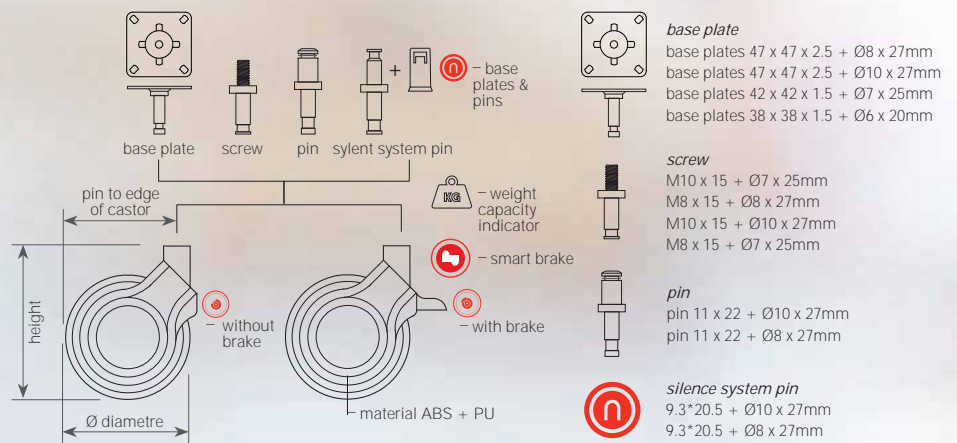

movement ideas



## OLYM CASTOR WITH BRAKE

| ITEM 1513

*Material* | white & black, ABS core, PU & zink alloy  
*Characteristics* | with brakes  
*Recommended* | decor / office / design  
*Code* | RIH1324

					
<i>Reference</i>	Ø75mm	96.5mm	26mm	50kg	M10x15mm



## OLYM NEO CASTOR WITHOUT BRAKE

| ITEM 660

*Material* | black, ABS core, PU & PA  
*Characteristics* | no brakes  
*Recommended* | decor / office / design / kids  
*Code* | RIH2216





					
<i>Reference</i>	Ø60mm	84mm	27mm	25kg	M10x15mm



## KOO CASTOR WITHOUT BRAKE

| ITEM 1512

*Material* | grey & white, AB, PU & zink alloy  
*Characteristics* | no brakes  
*Recommended* | decor / office / design / kids  
*Code* | RIH1323

					
<i>Reference</i>	Ø75mm	93.5mm	42mm	50kg	M10x15mm



## KOO CASTOR WITH BRAKE

| ITEM 1514





*Material* | white & black, AB, PU & zink alloy  
*Characteristics* | with brakes  
*Recommended* | decor / office / design / kids  
*Code* | RIH1322

					
<i>Reference</i>	Ø75mm	93.5mm	42mm	50kg	M10x15mm

## KOO CASTOR BLACK

| ITEM 661





*Material* | black, PA & PU  
*Characteristics* | no brakes  
*Recommended* | decor / office / design  
*Code* | RIH2217

					
<i>Reference</i>	Ø65mm	72.5mm	42mm	40kg	11x22mm + Ø10x27

## KOO CASTOR BLACK SILENT PIN

| ITEM 662

*Material* | black, PA & PU  
*Characteristics* | no brakes  
*Recommended* | decor / office / design  
*Code* | RIH2218

					
<i>Reference</i>	Ø65mm	72.5mm	42mm	40kg	9.2x20.5mm + Ø10x27



KOO



# Eva



## EVA CASTOR GREY WITH BRAKE

| ITEM 1522

*Material* | dark & light grey, PP+TPR & PA+zink alloy  
*Characteristics* | with brakes  
*Recommended* | decor / office / kids / medical  
*Code* | RIH1321



*Reference* | Ø75mm 89.5mm 44mm 40/48kg M10x15mm

## EVA CASTOR GREY WITH PLATE

| ITEM 658

*Material* | dark & light grey, PP+TPR & PA+zink alloy  
*Characteristics* | no brakes  
*Recommended* | decor / office / kids / medical  
*Code* | RIH2214



*Reference* | Ø60mm 71mm 44mm 36/44kg 47x47mm

## EVA CASTOR GREY WITH SCREW

| ITEM 659

*Material* | dark & light grey, PP+TPR & PA+zink alloy  
*Characteristics* | no brakes  
*Recommended* | decor / office / kids / medical  
*Code* | RIH2215



*Reference* | Ø60mm 71mm 44mm 36/44kg M8x15mm

# Dickson

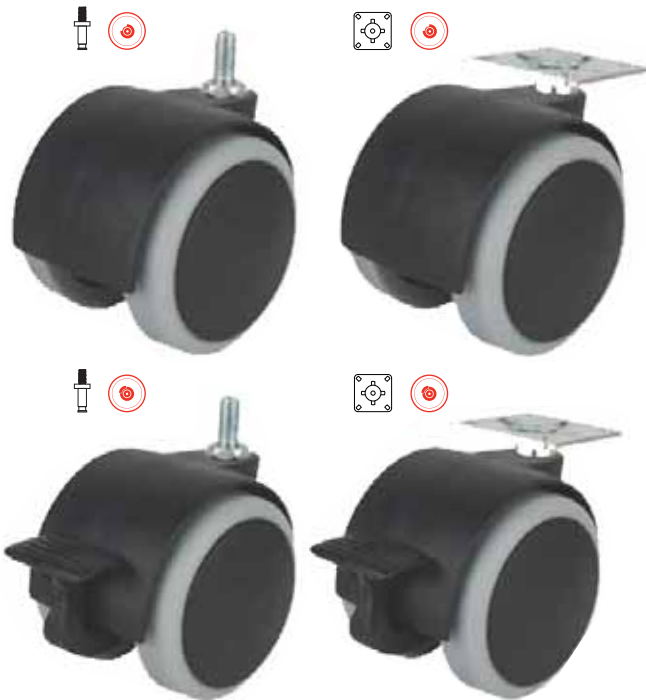

## DICKSON CASTOR WITHOUT BRAKES

| ITEM 670/672

*Material* | grey, PA+PU & PA  
*Characteristics* | no brakes, option with screw or plate  
*Recommended* | decor / office / kids / medical / cradle  
*Code* | RIH2225 | RIH2226

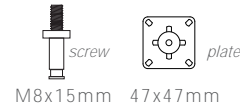

M8x15mm 47x47mm



*Reference* | Ø50mm 54.5mm 50mm 26kg

## DICKSON CASTOR WITH BRAKES

| ITEM 667/668

*Material* | grey, PA+PU & PA  
*Characteristics* | with brakes, option with screw or plate  
*Recommended* | decor / office / kids / medical / cradle  
*Code* | RIH2223 | RIH2224

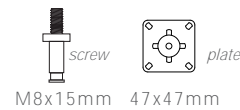

M8x15mm 47x47mm

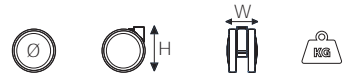

*Reference* | Ø50mm 54.5mm 50mm 26kg

# Aluminium



## ALUMINIUM CASTORS

| ITEM 676

*Material* | black, PA  
*Characteristics* | with brakes  
*Recommended* | decor / design / office  
*Code* | RIH821

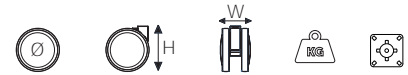

*Reference* | Ø75mm 95mm 110mm 60kg 47x47mm

# Enid



## ENID CASTOR GREY WITH PLATE





| ITEM 693

*Material* | grey, PP+TPE  
*Characteristics* | no brakes  
*Recommended* | decor / kids  
*Code* | RIH2243

*Reference* |  Ø40mm  44.5mm  34mm  22kg  plate

## ENID CASTOR GREY WITH SCREW - ITEM 694

*Material* | dark & light grey, PP+TPR & PA+zink alloy  
*Characteristics* | no brakes  
*Recommended* | decor / kids  
*Code* | RIH2244

*Reference* |  Ø40mm  44.5mm  34mm  22kg  screw



# Ivy







## IVY CASTOR WITHOUT BRAKES

| ITEM 685/686

*Material* | white & grey, PP+TPE  
*Characteristics* | no brakes, option with screw or pin  
*Recommended* | decor / kids / cradle  
*Code* | RIH2235 | RIH2236



 screw  pin  
M8x15mm 11x22+Øx27mm





*Reference* |  Ø60mm  66mm  43.5mm  28kg

## IVY CASTOR WITH BRAKES

| ITEM 687/688

*Material* | white & grey, PP+TPE  
*Characteristics* | with brakes, option with screw or pin  
*Recommended* | decor / kids / cradle  
*Code* | RIH2237 | RIH2238

 screw  pin  
M8x15mm 11x22+Øx27mm

*Reference* |  Ø60mm  66mm  43.5mm  28kg



# Laia



## LAIA CASTOR WITHOUT BRAKES

| ITEM 665/666

**Material** | grey & black, PA+PU & PA + zink alloy  
**Characteristics** | no brakes, option with screw or plate  
**Recommended** | decor / design / kids / medical  
**Code** | [RIH2221](#) | [RIH2222](#)



M8x15mm 47x47mm



**Reference** | Ø60mm 71.5mm 42mm 36/44kg

## LAIA CASTOR WITH BRAKES

| ITEM 663/664

**Material** | grey & black, PA+PU & PA + zink alloy  
**Characteristics** | with brakes, option with screw or plate  
**Recommended** | decor / design / kids / medical  
**Code** | [RIH2219](#) | [RIH2220](#)



M8x15mm 47x47mm



**Reference** | Ø60mm 71.5mm 42mm 36/44kg

# Bailey



## BAILEY CASTOR WITHOUT BRAKES

| ITEM 689/690

**Material** | grey & black, PA+PU  
**Characteristics** | no brakes, option with pin or silence pin system  
**Recommended** | decor / design / office / kids / medical / cradle  
**Code** | [RIH2239](#) | [RIH2240](#)



11x22mm  
 Ø10x27



**Reference** | Ø65mm 67mm 45mm 30kg

## BAILEY CASTOR WITH BRAKES

| ITEM 691/692

**Material** | grey & black, PA+PU  
**Characteristics** | with brakes, option with pin or silence pin system  
**Recommended** | decor / design / kids / medical  
**Code** | [RIH2241](#) | [RIH2242](#)



11x22mm  
 Ø10x27



**Reference** | Ø65mm 67mm 45mm 30kg

# Anna



## ANNA CASTOR WITH BRAKES

| ITEM 697

**Material** | black, PA  
**Characteristics** | with brakes and plate  
**Recommended** | decor / design  
**Code** | [RIH2247](#)



42x42mm

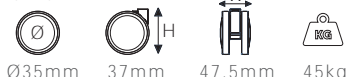

**Reference** | Ø35mm 37mm 47.5mm 45kg



# Ferrari

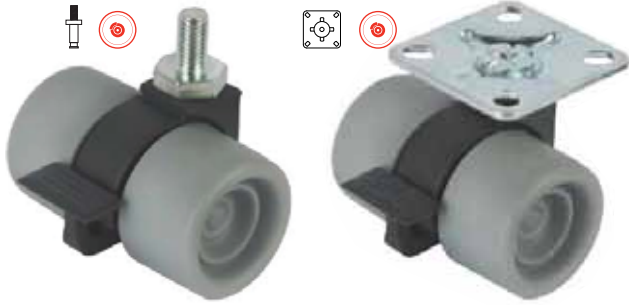

## FARRARI CASTOR WITH BRAKES

| ITEM 699/698

*Material* | grey & black, PA  
*Characteristics* | with brakes, option with screw or plate  
*Recommended* | kids / office / design  
*Code* | RIH2249 | RIH2248

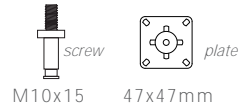

M10x15 47x47mm

*Reference* | Ø38mm 41mm 66mm 75kg

# Bola



## BOLA CASTOR WITH BRAKES

| ITEM 940/939

*Material* | black, PA+PU  
*Characteristics* | with brakes, option with screw or plate  
*Recommended* | decor / office / kids / medical / cradle  
*Code* | RIH2253 | RIH2252

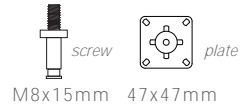

M8x15mm 47x47mm

*Reference* | Ø50mm 88mm 53mm 30kg

# Maria



## MARIA CASTOR WITHOUT BRAKES

| ITEM 1107

*Material* | chrome & grey, PP+TPR & iron  
*Characteristics* | no brakes, with fixed plate  
*Recommended* | decor / design  
*Code* | RIH2262



*Reference* | Ø50mm 70.5mm 61.5mm 26kg fixed

# Liz



## LIZ CASTOR WITHOUT BRAKES

| ITEM 784

*Material* | grey, PP+TPR  
*Characteristics* | no brakes, with fixed plate  
*Recommended* | beds / couch  
*Code* | RIH2251



*Reference* | Ø30mm 40mm 22.6mm 29kg fixed

# Loy



## LOY CASTOR WITHOUT BRAKES

| ITEM 777

*Material* | grey, PP+TPR  
*Characteristics* | no brakes, with fixed plate  
*Recommended* | beds / couch  
*Code* | RIH2250



*Reference* | Ø30mm 33mm 22mm 58kg fixed

# Erica



## ERICA MINI CASTORS

| ITEM 1631/1630

*Material* | black, PA  
*Characteristics* | no brakes & with brakes, both with flat base  
*Recommended* | kids / cradle / medical  
*Code* | **RIH1431** | **RIH1430**  
 no brakes with brakes

*Reference* |  Ø50mm  55mm  45mm  45kg  47x47mm

## ERICA CASTORS

| ITEM 695/696

*Material* | black, PA  
*Characteristics* | no brakes & with brakes, both with plates  
*Recommended* | kids / cradle / medical  
*Code* | **RIH2245** | **RIH2246**  
 no brakes with brakes

*Reference* |  Ø40mm  45mm  45mm  30kg  47x47mm

# Polyurethane



## POLYURETHANE CASTORS

| ITEM 674

*Material* | clear, polyurethane  
*Characteristics* | no brakes & with brakes, both with plates  
*Recommended* | decor / design / kids  
*Code* | **RIH816** | **RIH817**  
 no brakes with brakes

*Reference* |  Ø75mm  97mm  39mm  55kg  47x47mm

## POLYURETHANE CASTORS

| ITEM 673

*Material* | clear, polyurethane  
*Characteristics* | no brakes & with brakes, both with plates  
*Recommended* | decor / design / kids  
*Code* | **RIH822** | **RIH823**  
 no brakes with brakes

*Reference* |  Ø50mm  64mm  35mm  55kg  38x38mm

# Emma



## EMMA CASTOR WITH FIXED PLATE

| ITEM 657

*Material* | clear, PC+PU & iron  
*Characteristics* | no brakes & fixed plate  
*Recommended* | decor / kids / medical / design  
*Code* | **RIH2213**

*Reference* |  Ø50mm  64mm  35mm  40kg  42 x 42mm

# Frog.S



## FROG.S CASTORS BLACK

| ITEM 941/942

*Material* | black, PA  
*Characteristics* | pin with smart brake & silent pin with smart brake  
*Recommended* | decor / design / office  
*Code* | **RIH2254** | **RIH2255**



11x22mm  
 Ø10x27



*Reference* | Ø65mm | 75.5mm | 54mm | 50kg



## FROG.S CASTORS GREY

| ITEM 943/944

*Material* | grey, PA  
*Characteristics* | pin with smart brake & silence pin with smart brake  
*Recommended* | decor / design / office  
*Code* | **RIH2256** | **RIH2257**



11x22mm  
 Ø10x27



*Reference* | Ø65mm | 75.5mm | 54mm | 50kg

# Frog.C



## FROG.C CASTORS BLACK

| ITEM 945/946

*Material* | black, PA  
*Characteristics* | pin with no brakes & silence pin with no brakes  
*Recommended* | decor / design / office  
*Code* | **RIH2258** | **RIH2259**



11x22mm  
 Ø10x27



*Reference* | Ø65mm | 75.5mm | 54mm | 60kg



## FROG.C CASTORS GREY

| ITEM 947/1101

*Material* | grey, PA  
*Characteristics* | pin with no brakes & silence pin with no brakes  
*Recommended* | decor / design / office  
*Code* | **RIH2260** | **RIH2261**



11x22mm  
 Ø10x27



*Reference* | Ø65mm | 75.5mm | 54mm | 60kg



**smart brake**  
 Designed by de Jose Vázquez



**silence system**  
 Designed by Rafa Ortega





## GORDON CASTOR BLACK WITHOUT BRAKES

Material | black, PA+ABS  
 Characteristics | no brakes, option with screw, pin, silence pin, plate  
 Recommended | decor / office / kids / medical / cradle  
 Item number | 1108 | 1146 | 1183 | 1124  
 Code | **RIH2295** | **RIH2297** | **RIH2298** | **RIH2296**

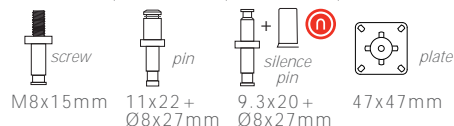

M8x15mm | 11x22+  
Ø8x27mm | 9.3x20+  
Ø8x27mm | 47x47mm



Reference | Ø50mm | 53mm | 50mm | 40kg

## GORDON CASTOR BLACK WITH BRAKES

Material | black, PA+ABS  
 Characteristics | with brakes, option with screw, pin, silence pin, plate  
 Recommended | decor / office / kids / medical / cradle  
 Item number | 681 | 683 | 684 | 682  
 Code | **RIH2231** | **RIH2233** | **RIH2234** | **RIH2232**

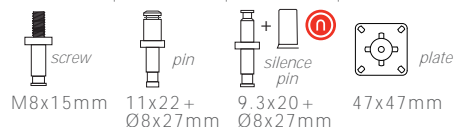

M8x15mm | 11x22+  
Ø8x27mm | 9.3x20+  
Ø8x27mm | 47x47mm



Reference | Ø50mm | 53mm | 50mm | 40kg

## GORDON CASTOR CHROME WITHOUT BRAKES

Material | chrome & black, PA+ABS  
 Characteristics | no brakes, option with screw, pin, silence pin, plate  
 Recommended | decor / office / kids / medical / cradle  
 Item number | 675 | 679 | 680 | 677  
 Code | **RIH2227** | **RIH2229** | **RIH2230** | **RIH2228**

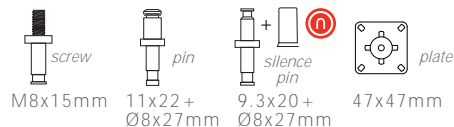

M8x15mm | 11x22+  
Ø8x27mm | 9.3x20+  
Ø8x27mm | 47x47mm



Reference | Ø50mm | 53mm | 50mm | 62.5kg

## GORDON CASTOR CHROME WITH BRAKES

Material | chrome & black, PA+ABS  
 Characteristics | with brakes, option with screw, pin, silence pin, plate  
 Recommended | decor / office / kids / medical / cradle  
 Item number | 1184 | 1188 | 1189 | 1186  
 Code | **RIH2299** | **RIH2301** | **RIH2302** | **RIH2300**

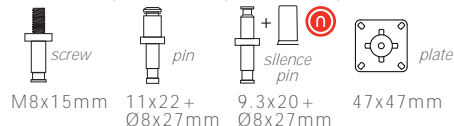

M8x15mm | 11x22+  
Ø8x27mm | 9.3x20+  
Ø8x27mm | 47x47mm



Reference | Ø50mm | 53mm | 50mm | 62.5kg





# RAIÈL CATALOGUE VOLUME 8

proud  
distributors  
of the  
following  
brands:



OFFICE &  
KITCHEN

# Drawers

## AND ACCESSORIES FOR WORK STATIONS AND CUPBOARDS

The RAIËL OFFICE DRAWER is a durable and stylish solution for office furniture. The drawer is available with clip-in euroslide or a ball bearing slide option. Standard runners and ball bearings are able to fit on the drawers and can be done upon request. Drawers are black epoxy coated. Load capacities: Euro Slide: 10 - 25kg / Ball Bearing Slide: 15 - 35kg

## Raiël Drawers

Drawer front drilling detail

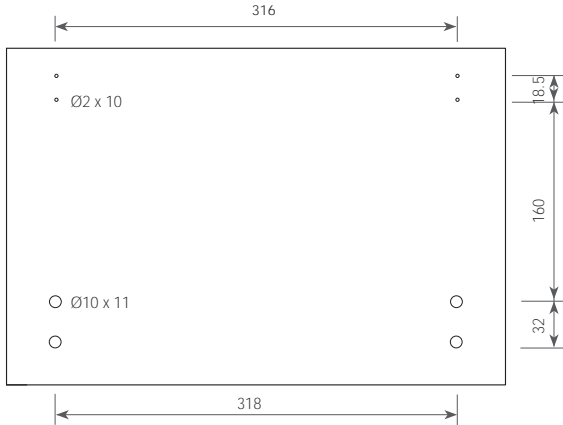

Internal Cabinet Detail

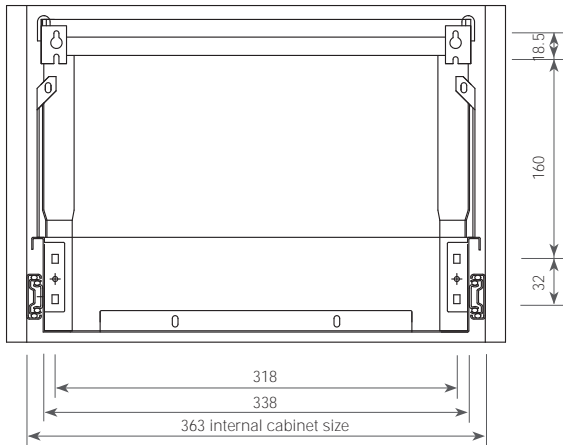

## Drawer Accessories

### OFFICE DRAWER

ITEM 1393

Material | metal

Size | 363 x 400mm

inc. ball bearings - pack of 10 | RIH2308

exc. ball bearings - pack of 10 | RIH1849

### OFFICE DRAWER

ITEM 1394

Material | metal

Size | 363 x 400mm

inc. drawer slides - pack of 10 | RIH2307

exc. drawer slides - pack of 10 | RIH1851

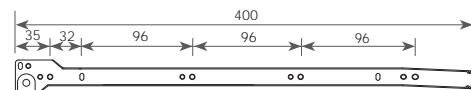
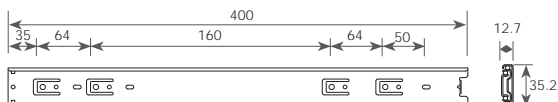

Made to Order Products (MTO) - non standard drawer widths available on request.

# Impaz Filing System



## FILING DRAWER SET

Material | metal  
 Finish | 1102 - grain black  
 pack of 10

| ITEM 1394

| RIH1852

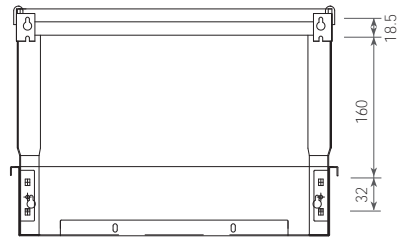

1102  
 grain  
 black

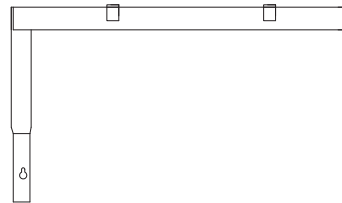

## FILING DRAWER SUPPORT BRACKET CLIP IN

Material | metal  
 Finish | 1102 - grain black  
 pack of 10 pairs

| ITEM 1394

| RIH2114

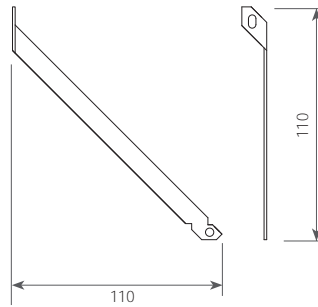

1102  
 grain  
 black



## FILING DRAWER SUPPORT BRACKET

Material | metal  
 Finish | 1102 - grain black

| ITEM 1803

| RIH1620

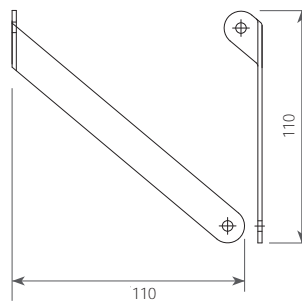

1102  
 grain  
 black

# Drawer Accessories



## ADJUSTABLE STATIONARY TRAY | ITEM 320

Material | plastic  
 Size | 333-460 x 235 x 27mm  
 Finish | 602 - black | RIH2172

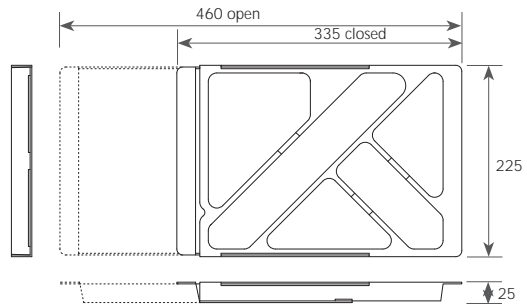

602  
black

## STATIONARY TRAY | ITEM 321

Material | plastic  
 Size | 345 x 166 x 30mm  
 Finish | 602 - black | RIH2173

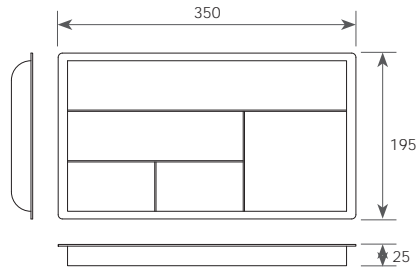

602  
black

## STATIONARY TRAY | ITEM 322

Material | plastic  
 Size | 350 x 78 x 25mm  
 Finish | 602 - black | RIH2174

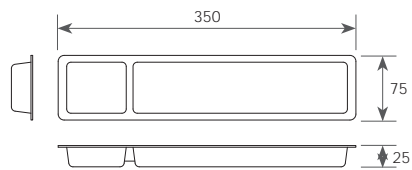

602  
black





# Modesty Panels

FOR OFFICE DESKING  
AND WORKSTATIONS

Modesty panels and screens provide a stylish addition to your desk or workstation. They enhance privacy and can be useful for concealing under desk wiring and equipment, without compromising the aesthetic appeal of your office environment. Modesty panels and screens are great for promoting a tidy visual appearance to your workplace and can offer subtle design enhancements to your office.



**1200 SCREEN - for 1350 - 1600mm desking** | ITEM 1349

Material | steel

Finish | 1101 - grain white

| RIH2109



1101  
grain  
white

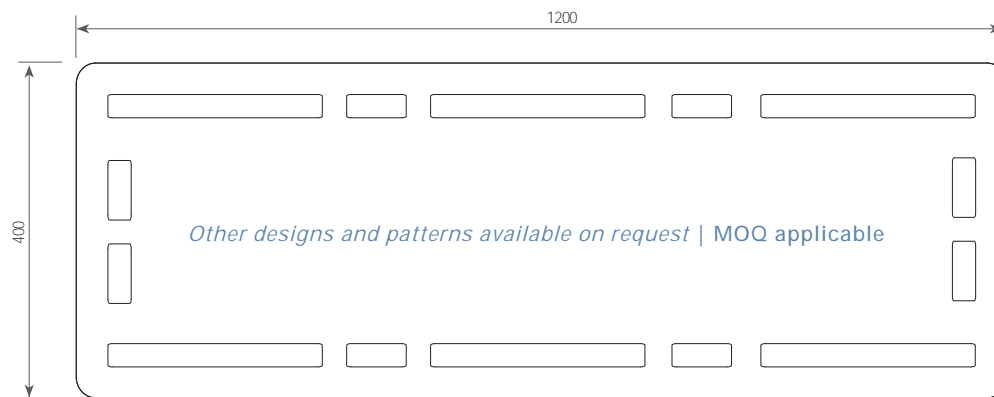

**1450 SCREEN - for 1600 - 2000mm desking** | ITEM 1349

Material | steel

Finish | 1101 - grain white

| RIH2110



1101  
grain  
white

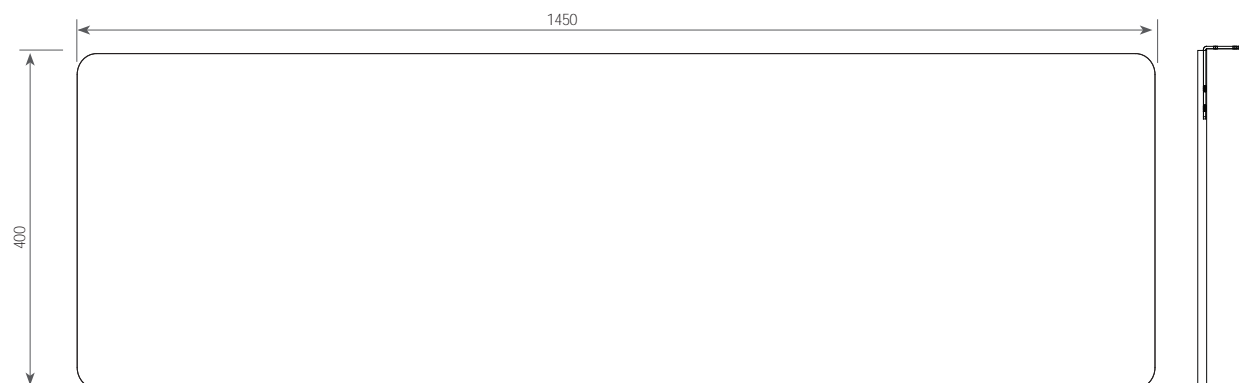

# Accessories



1103  
silver  
powder coat

## KNIGHT CLAMP

| ITEM 279

Material | zink  
Size | for 16mm board  
Colour | 1103 - silver powder coat | RIH2144

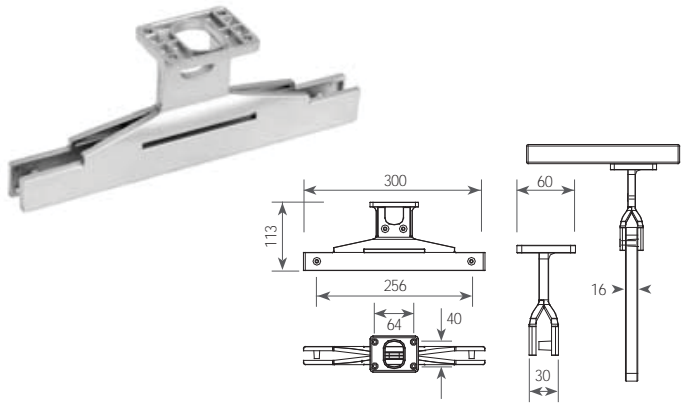

1101  
grain  
white

## GENTLEMAN CLAMP

| ITEM 280

Material | zink  
Size | for 16mm board  
Colour | 1101 - grain white | RIH2145

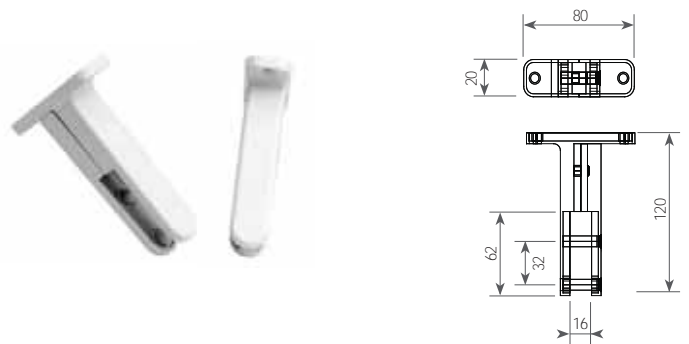

1001  
gloss  
white

104  
CH  
chrome

## PARTITION CLAMP

| ITEM 281

Material | steel  
Finish | 1101 - grain white | RIH2146

## ACCESSORY

| ITEM 284

Size | for 16mm board  
Finish | 104 - chrome | RIH2147

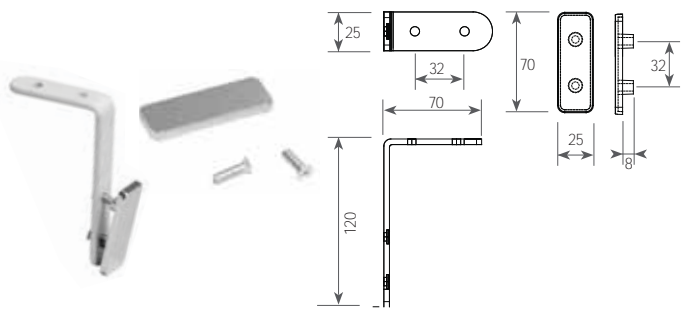

1103  
silver  
powder coat

## PARTITION CLAMP

| ITEM 275

Material | zink  
Finish | 1103 - silver powder coat | RIH2141

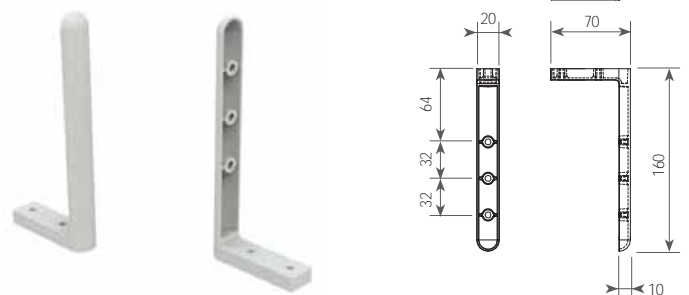

# Accessories

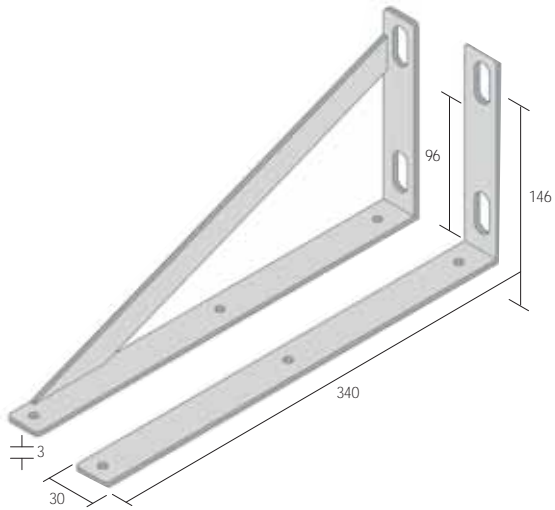

## MODESTY PANEL BRACKET

| ITEM 1637

Material | metal  
 Finish | 1103 - silver powder coat  
 Code | with fixed support | RIH1443  
 | without support | RIH1566



1103  
 silver  
 powder coat

- modesty panels brackets sold with or without support



Modesty Panels



# Screen Brackets

FOR OFFICE DESKING  
 AND WORKSTATIONS



# Clamps

## PARTITION CLAMP UNDERMOUNT PJ4

| ITEM 284

Material | zink  
 Finish | 1101 - grain white | RIH2139  
 | 1103 - silver powder coat | RIH2140  
 | 1005 - matt black | RIH156



1101 grain white | 1103 silver powder coat | 1005 matt black



screen min 4mm to max 20mm

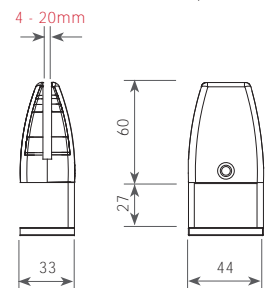

glass



rubber cushion for glass included

# Clamps



## PARTITION CLAMP UNDERMOUNT PJ101

ITEM 1667

Material | zink  
 Finish | 1103 - silver powder coat | RIH186  
 | 1005 - matt black | RIH2178

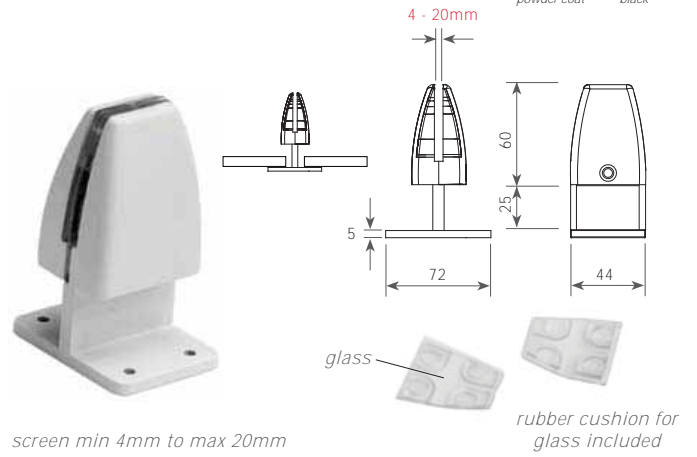

## PARTITION CLAMP SURFACE MOUNT PJ22

ITEM 278

Material | zink  
 Finish | 1101 - grain white | RIH2143  
 | 1103 - silver powder coat | RIH2142

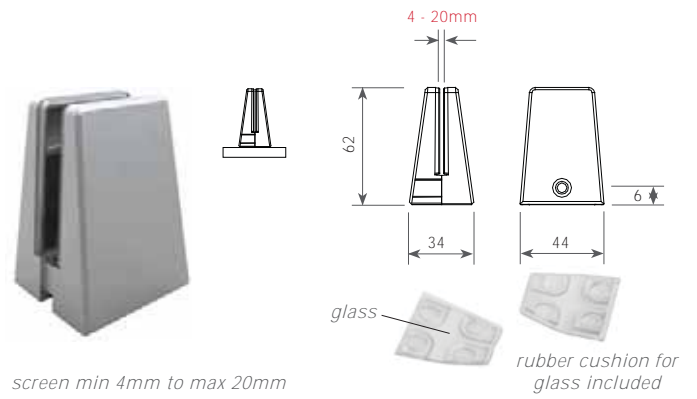

## PARTITION CLAMP UNDERMOUNT

ITEM 302

Material | zink  
 Finish | 1103 - silver powder coat | RIH1853

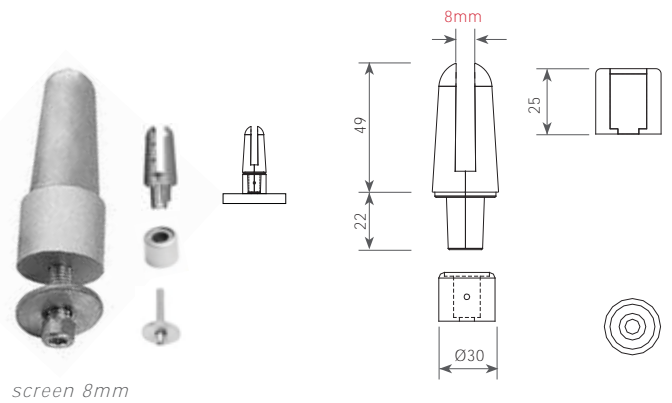



# Screen Bullets



## RECTANGULAR SCREEN BULLET

| ITEM 1636

Material | zink  
Finish | 103 - brush nickel  
          | 102 - matt chrome

| RIH1437  
| RIH1438



## GRUB SCREW M5 - for glass

| ITEM 1636

Material | metal  
Finish | nylon tip

| RSC197



## RECTANGULAR SCREEN BULLET FIXING BRACKET

| ITEM 1633

Material | steel  
Finish | 103 - brush nickel

| RIH1439

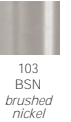

• fixing brackets which can fit the screen bullet

# Fixing Plates

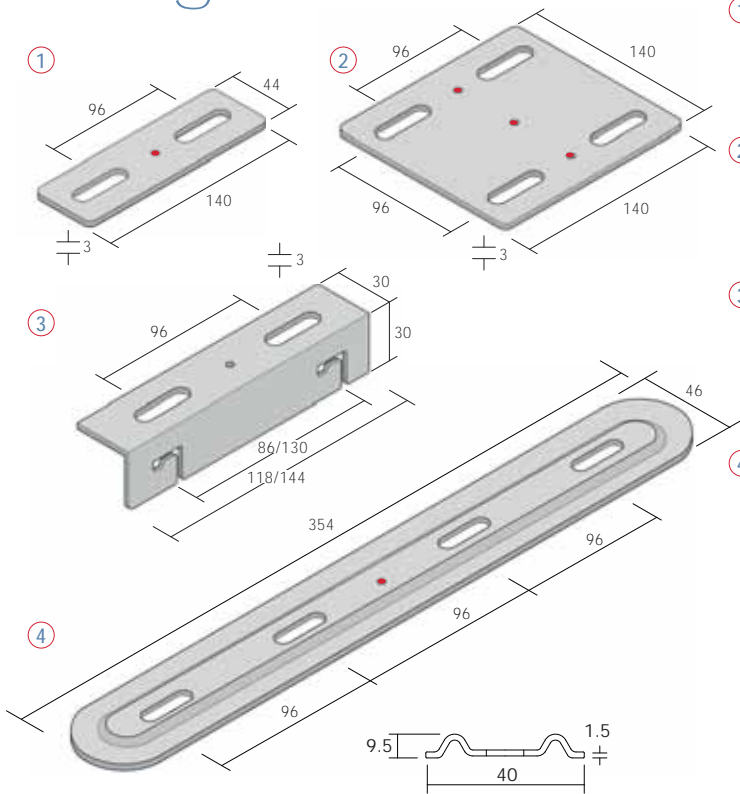

## 1 FIXING PLATE

| ITEM 1620

Material | metal  
Size | 140 x 44mm  
Finish | 1103 - silver powder coat

| RIH1442



## 2 FIXING PLATE

| ITEM 1619

Material | metal  
Size | 140 x 140mm  
Finish | 1103 - silver powder coat

| RIH1441

## 3 WIRE BASKET FIXING BRACKET

| ITEM 1617

Material | metal  
Size | 86mm | 130mm  
          | RIH1436 | RIH1626  
Finish | 1103 - silver powder coat

## 4 FIXING BRACKET

| ITEM 1618

Material | metal  
Size | 40mm width  
Finish | 1103 - silver powder coat

| RIH1440

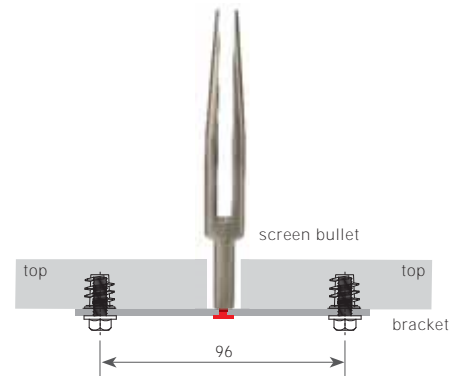

## SCREEN BRACKET

| ITEM 1638

Material | metal  
Size | 140 x 140mm  
Finish | 1103 - silver powder coat

| RIH1444

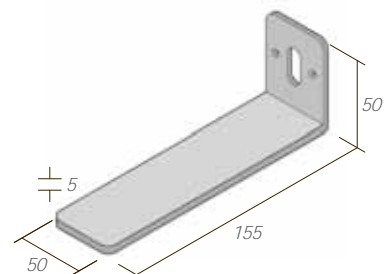

MORE THAN JUST A DOOR

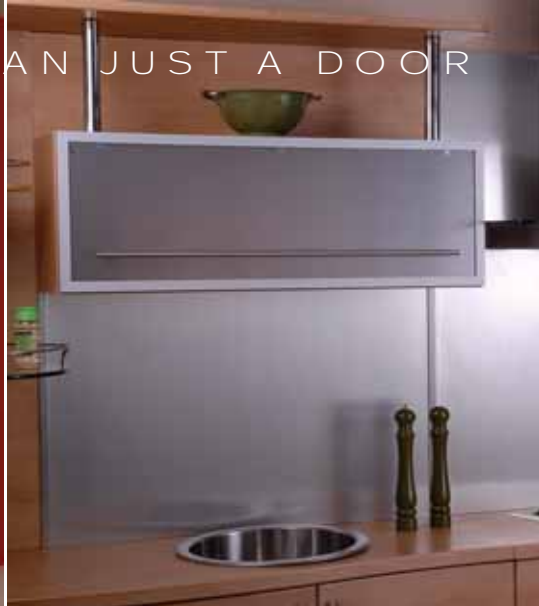

HINGES



**ferrari**  
the heart of furniture

EXCITE INSPIRE REWARD



# Cable Managements

FOR OFFICE DESKING

We are all connected, and while more and more technologies are going wireless, there are still plenty of cables to go around. With so many cables and cords connecting to so many different devices, it doesn't take long before you're being consumed in a sea of tangle wires.

Raiel (Pty)Ltd has cable management products that will take care of all of your needs. Whether you're outfitting the home, office, or industrial facility, we are sure you'll find a solution that fits your application.



# Cable Management



## OFFICE WORM

Material | ABS  
 Size | 700/1100mm maximum  
 Finish | 602 - black  
 1103 - silver powder coat

| ITEM 10

| RIH1710  
 | RIH1711



## WORM T20

Material | Plastic  
 Size | 120 x 50mm  
 Finish | 602 - black  
 605 - silver

| ITEM 326

| RIH2175  
 | RIH2176

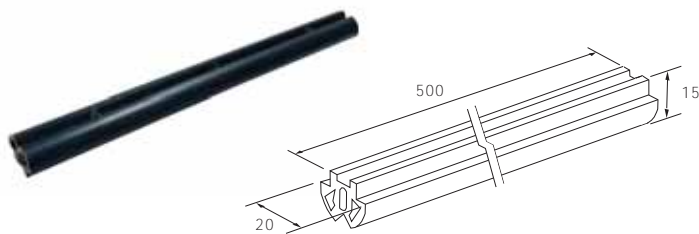
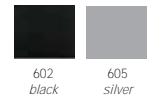

## WIRE FIXING STRIP

Material | ABS  
 Size | 500 x 20mm  
 Finish | 1102 - grain black

| ITEM 10

| RIH1712

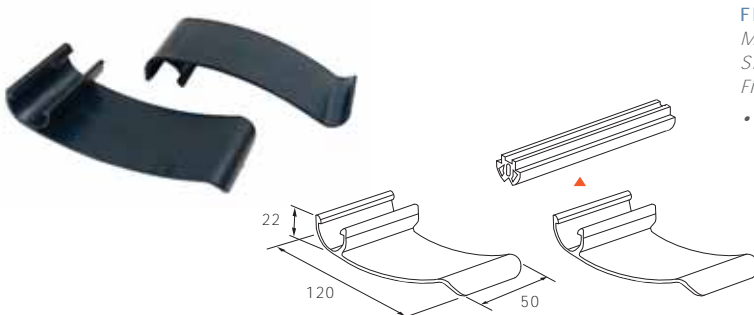
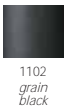

## FIXING BRACKET

Material | ABS  
 Size | 120 x 50mm  
 Finish | 1102 - grain black  
 • pack of four

| ITEM 10

| RIH1713

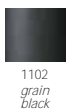





**CABLE MANAGEMENT**

Material | plastic  
 Size | 300 x 110 x 30mm  
 Finish | 605 - silver

ITEM 268  
 RIH2133

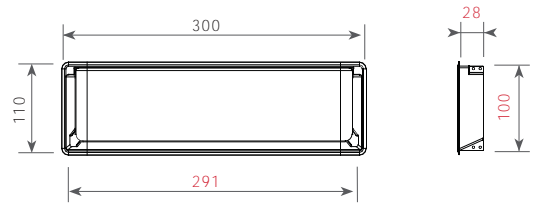

**CABLE MANAGEMENT**

Material | plastic  
 Size | 344 x 124 x 29mm  
 Finish | 605 - silver

ITEM 270  
 RIH2135

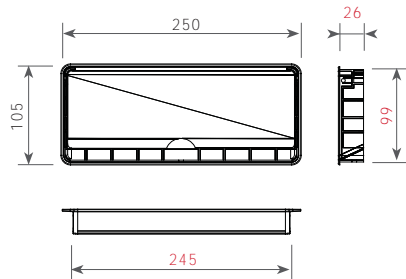
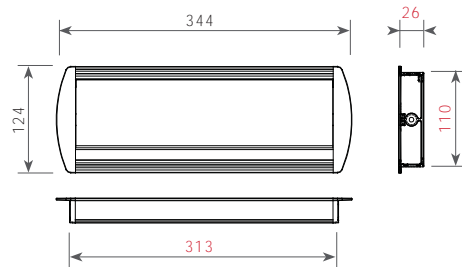

**PLASTIC CABLE BOX**

Material | plastic  
 Size | 250 x 105mm  
 Finish | 605 - silver/clear flap  
 601 - white  
 602 - black  
 605 - silver

ITEM 265  
 RIH2129  
 RIH2131  
 RIH2130  
 RIH2132

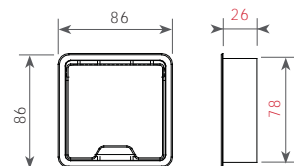
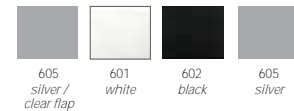

**PLASTIC CABLE BOX**

Material | plastic  
 Size | 78 x 78mm  
 Finish | 605 - silver/clear flap

ITEM 269  
 RIH2134

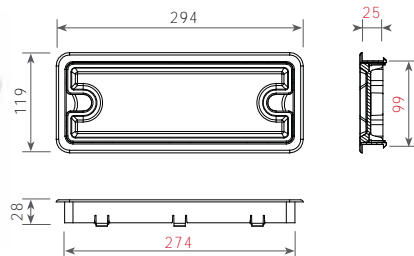

**DESKTOP PENCIL CASE**

Material | plastic  
 Size | 294 x 120 x 28mm  
 Finish | 601 - white  
 602 - black  
 605 - silver

ITEM 272  
 RIH2136  
 RIH2137  
 RIH2138



# Cable Management

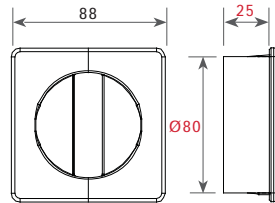

## PLASTIC CABLE BOX - SQUARE | ITEM 297

Material | aluminium  
 Size | 80 x 80mm  
 Finish | 601 - white | RIH2157  
 605 - silver | RIH2158

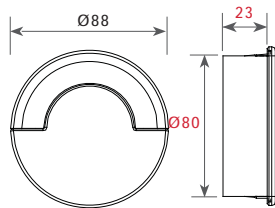
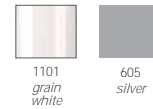

## PLASTIC CABLE BOX - ROUND | ITEM 299

Material | plastic  
 Size | Ø80 x 80mm  
 Finish | 601 - white | RIH2159  
 605 - silver | RIH2160

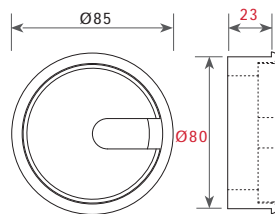
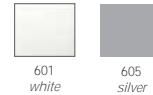

## WIRE MANAGEMENT - ROUND | ITEM 1592

Material | wood  
 Size | Ø80 x 23mm  
 Finish | 401 - oak | RWM996  
 410 - ghost white | RWM997  
 411 - embuia stain | RWM998

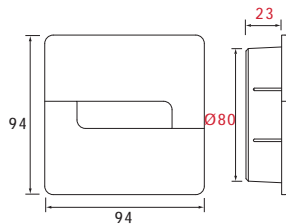

## SQUARE WIRE MANAGEMENT | ITEM 1558

Material | plastic  
 Size | 80mm  
 Finish | 605 - silver | RIH1028

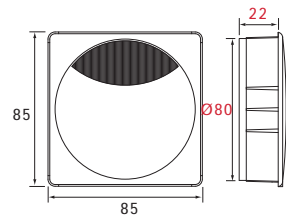

## SQUARE WIRE MANAGEMENT | ITEM 1554

Material | plastic  
 Size | 80mm  
 Finish | 602 - black | RIH1316  
 103 - BSN/brushed nickel | RIH1317

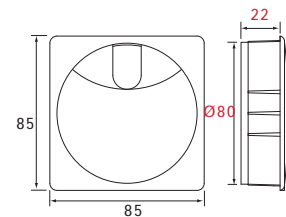
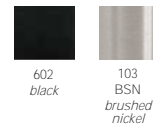

## SQUARE WIRE MANAGEMENT | ITEM 1555

Material | plastic  
 Size | 80mm  
 Finish | 602 - black | RIH1315

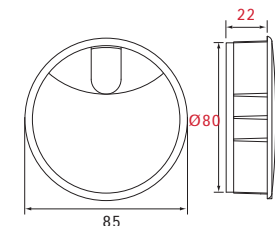
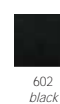

## ROUND WIRE MANAGEMENT | ITEM 1556

Material | plastic  
 Size | 80mm  
 Finish | 602 - black | RIH1314



## HOLE SAW CUTTER | ITEM 1800

Material | metal  
 Size | Ø60mm | RIH1616  
 Ø80mm | RIH1615

# Cable Management



## WIRE MANAGEMENT | ITEM 1503

Material | plastic  
 Size | Ø80mm  
 Finish | 103 - BSN/brushed nickel | RIH1313  
 601 - white | RIH1312  
 602 - black | RIH1311

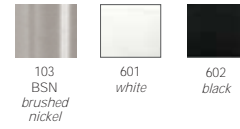

## PLASTIC ROUND WIRE MANAGEMENT | ITEM 1536

Material | plastic  
 Size | Ø80mm  
 Finish | 602 - black | RIH1247  
 604 - oak | RIH1248  
 605 - silver | RIH1629

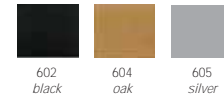

## PLASTIC ROUND WIRE MANAGEMENT | ITEM 921

Material | plastic  
 Size | Ø60mm  
 Finish | 602 - black | RIH646  
 604 - oak | RIH647  
 606 - grey | RIH648  
 605 - silver | RIH1866

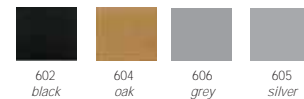

## CABLE OUTLETS | ITEM 1136

Material | plastic  
 Size | 240 x 80 x 13mm - oblong | RKW433  
 80 x 80 x 13mm - square | RKW434  
 MTO | / MQ - 10 per size. 4-6 weeks lead time  
 Finish | 101 - NA/natural anodised



Special Sizes - **mto** Made to Order Products (MTO)

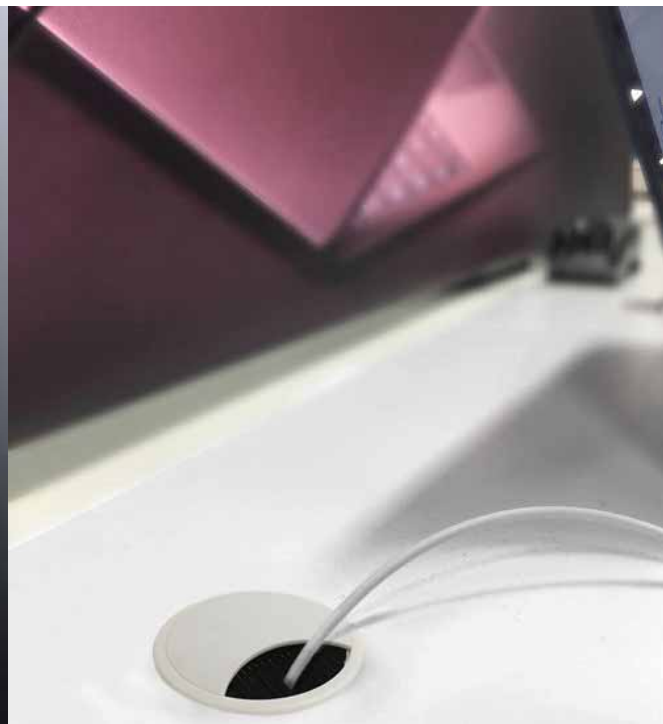

# Cable Management

86 x 1200mm

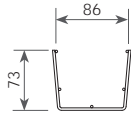

130 x 1200mm

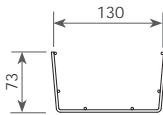
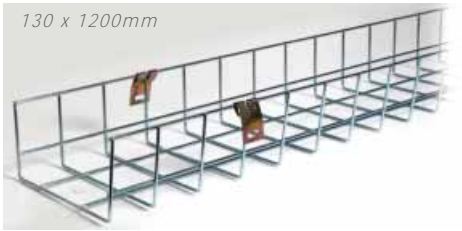

350 x 1200mm

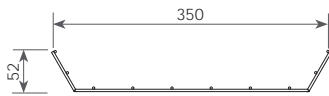
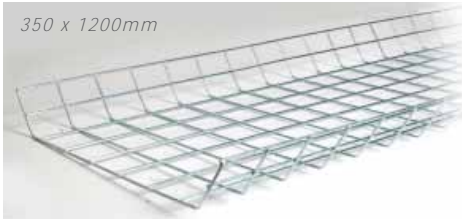

## WIRE BASKET FIXING BRACKET

| ITEM 1617

Material

Size

86mm x 1200mm\*

130mm x 1200mm\*

350mm x 1200mm\*\*

| RIH1420

| RIH1625

| RSR022

Finish

| 1103 - silver powder coat



1103  
silver  
powder coat

\* Includes 4 x clips with each bracket

\*\* Supplied WITHOUT clips

## WIRE BASKET BEAM

| ITEM 1392

Extras

| including fixing bracket

Size

length - 550mm\*

length - 850mm\*

length - 1200mm\*

\* includes 2 clips

| RIH2111

| RIH2112

| RIH2113

Finish

| 1102 - grain black



1102  
grain  
black

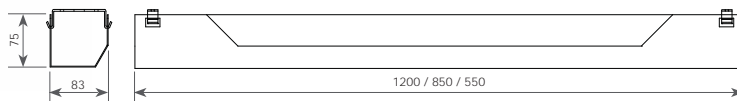

closed bracket

## WIRE BASKET FIXING BRACKET

| ITEM 1617

Material

Size

86mm

130mm

Finish

| 1103 - silver powder coat

| RIH1436

| RIH1626



1103  
silver  
powder coat

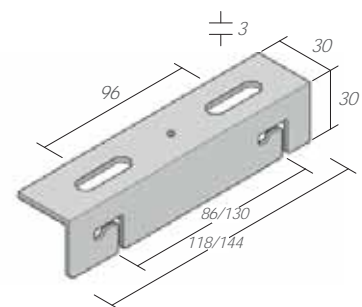

open bracket

## EXTRA BASKET CLIPS

| ITEM 1617

Material | metal

| RIH1421



• Optional extra, use 70mm Straight Flush Bolt for easy access.

ITEM 847 | straight flush bolt | RIH716



# CPU Holders

## FOR OFFICE DESKING

- **TWO STANDARD** versions available
- **SWIVEL AND STRAP** fix type
- **ATTACH EASILY** to the underside of the work surface
- **PROTECTS** your computer - suspending your CPU off the floor protects it from bumps and dust
- **TRAVELS** with your desk - this is especially important when using *height adjustable desks*
- **MAXIMIZE** available space underneath desking
- **AVAILABLE FINISHES**

Matt White	Matt Black	Silver
------------	------------	--------

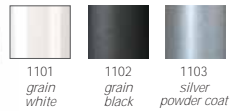

### CPU HOLDER SWIVEL

| ITEM 1530

**Features** | Attaches to underside of work surface  
 Moves in and out on a glide track with a 180° swivel rotation  
 Minimum - maximum height = 280 - 460mm  
 Minimum - maximum width = 155 - 220mm

<b>Material</b>   powder coated steel	MOQ   10
<b>Finish</b>   1101 - grain white	RSN023
1102 - grain black	RSN024
1103 - silver powder coat	RSN025

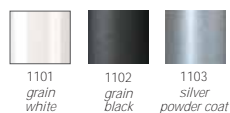
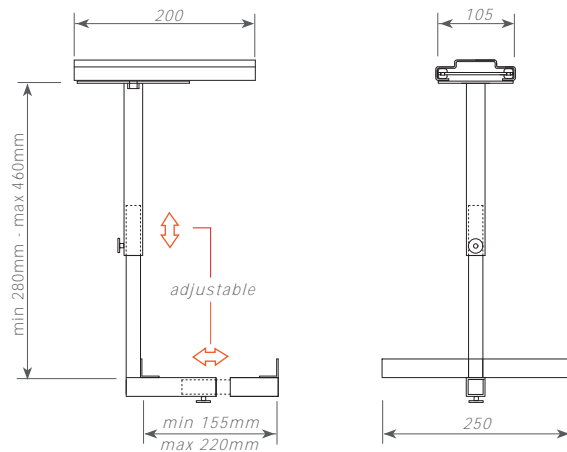

### CPU HOLDER WITH ADJUSTABLE STRAP

| ITEM 1537

**Features** | Attaches to underside of work surface  
 CPU fixed in place by adjustable black strap

<b>Material</b>   powder coated steel	MOQ   10
<b>Finish</b>   1101 - grain white	RSN026
1102 - grain black	RSN027
1103 - silver powder coat	RSN028

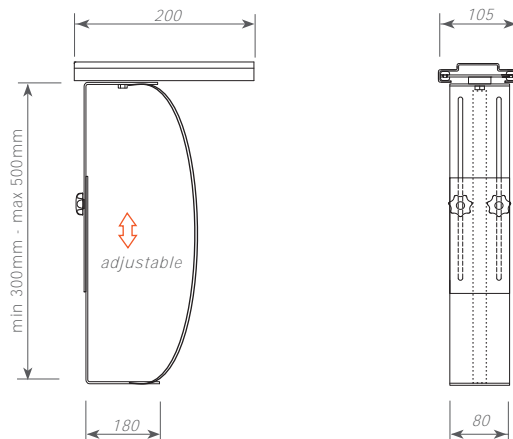

# Door Profiles

## ALUMINIUM GLASS DOOR PROFILES & COMPONENTS

Raiël (Pty)Ltd offers a range of aluminium glass door profiles and components. All products are custom made to your specifications and no minimum quantity orders apply. All doors are fully assembled. All doors can be made to order in various profiles and glass finishes, depending on the specified requirements.

- \* Please note a technical information form will need to be completed and lead time from date of order will be confirmed.
- \* We advise, when placing the order, that all lower level doors and handles or knobs, which are fitted directly to the glass, be ordered, with toughened glass to prevent injury.
- \* All profiles can be purchased in lengths and the components Separately for DIY, however, the glass will not be supplied.



Made to Order Products (MTO)



### ORDERING INFORMATION

STEPS TO FOLLOW WHEN ORDERING COMPLETE MADE DOORS:

1. Choose glass type.
2. Indicate if you require the glass to be toughened.
3. Choose Aluminium profile.
4. Indicate - Size of door & handle hole positioning on glass or door frame.
5. Hinges are only supplied with the P1 frames.

ORDERING FORMS CAN BE DOWNLOADED FROM THE RAIËL WEBSITE  
[www.rael.com](http://www.rael.com)

JACK DOOR SYSTEMS ALUMINIUM FRAMED GLASS CABINET DOOR Quotation Form					
Tel: +27 (22) 482 7400		Quote No			
Fax: +27 (86) 271 4301		Date			
Email: <a href="mailto:rael@rael.com">rael@rael.com</a>		Job No			
CUSTOMER INFORMATION					
Company:		Fax:			
Contact:		Email:			
Tel:		Job No			
Closest Raiël (Pty) Ltd Branch:		Job No			
Job No		Job No			
DOOR SPECIFICATION					
Door Height (in mm)	1	2	3	4	5
Door Width (in mm)					
Quantity					
Door Type					
L/R Hand Door					
Right Hand Door					
Flip-up Door					
Drawer Front					
Aluminium Profile					
P1					
22x45mm					
P4 + P5					
22x45mm					
P6					
22x45mm					
4mm Glass					
No Glass					
Clear Toughened					
Specialist Toughened & Clear/Refractive					
Sound/Heat-reflect Vinyl					
Coloured Vinyl (Translucent)					
Clear Mirror with Safety Vinyl					
Toughened					
Cost per Door (excl VAT)	0.00	0.00	0.00	0.00	0.00
<b>Total Cost (incl VAT)</b>	<b>0.00</b>	<b>0.00</b>	<b>0.00</b>	<b>0.00</b>	<b>0.00</b>

Hinge & Handle Positioning...

⊙ Indicates Hinge Position  
 ● Indicates Handle Position

Please specify how many hinge pockets you require. If you don't we will drill the holes according to system specifications.

Select below preferred drilling for Hinge Holes

● Not and drill  
 ● Not only

Drawer Fronts...

Special Instructions  
**ADDITIONAL COST ON HANDLES, HINGES AND GAS SUPPORT**

Please check all details, sign and fax to 086 271 4301 before manufacture can start...

Order No \_\_\_\_\_  
 Signed \_\_\_\_\_ Date \_\_\_\_\_

# Door profiles & components

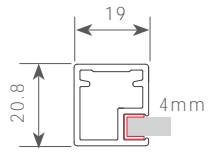
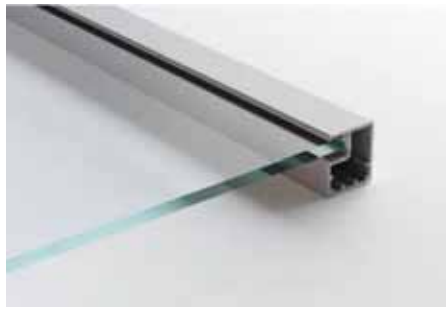

**① P1 PROFILE** | ITEM 77  
 Material | aluminium  
 Size | 20.8 x 19mm  
 Colour | 101 - natural anodised | RIH973

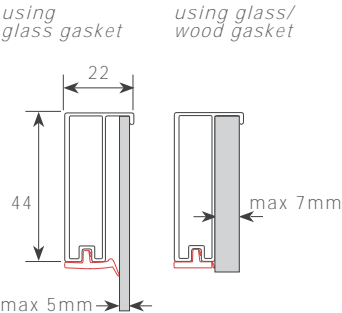
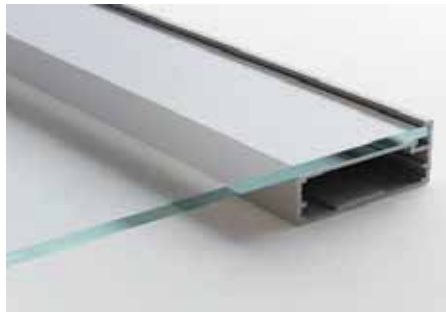

**② P4 PROFILE** | ITEM 530  
 Material | aluminium  
 Size | 44 x 22mm  
 Colour | 101 - natural anodised | RIH784  
 104 - chrome | RIH1250  
 106 - stainless steel | RIH1249

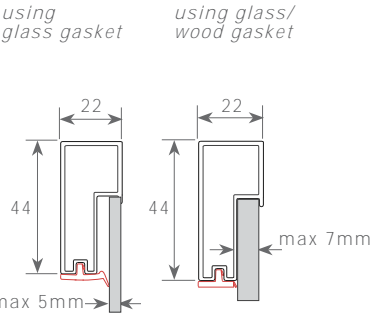
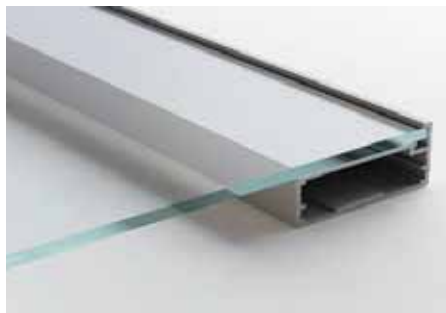
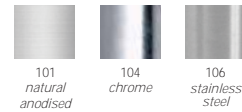

**③ P6 PROFILE** | ITEM 1272  
 Material | aluminium  
 Size | 44 x 22mm  
 Colour | 101 - natural anodised | RIH785

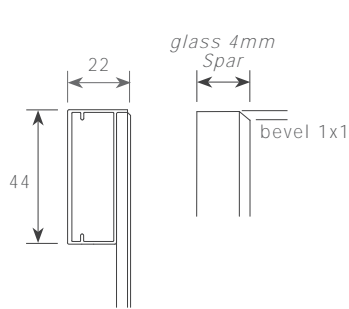
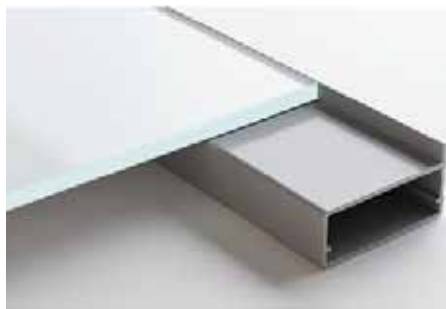

**④ P7 PROFILE** | ITEM 1305  
 Material | aluminium  
 Size | 44 x 22mm  
 Colour | 107 - stainless steel finish | RIH1251

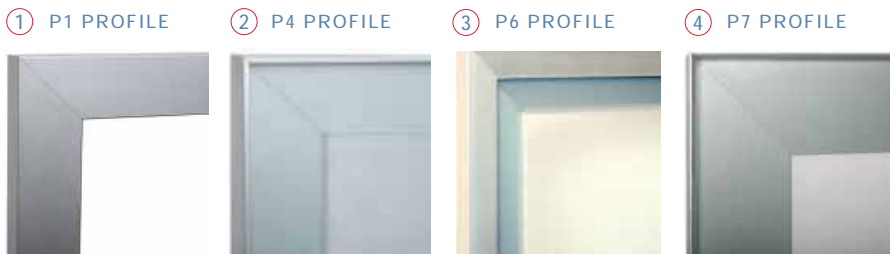

## 10 GLASS COLOURS



# Airvents

FOR OFFICE DESKING



## Main Frame Ventilation

Material | ABS  
 Size | 102 x 362mm  
 Finish | 1101 - grain white  
 606 - grey  
 1103 - silver powder coat

| ITEM 296

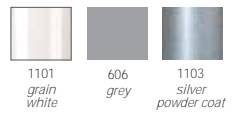

| RIH2154  
 | RIH2155  
 | RIH2156

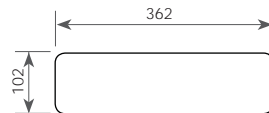

## Aluminium Airvent

Material | ABS  
 Size | 400 x 80mm  
 Finish | 1103 - silver powder coat

| ITEM 791



| RIH1108

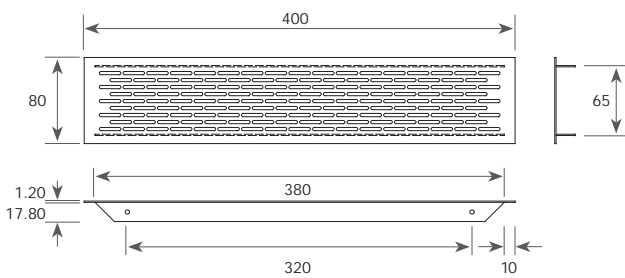

## Plastic Airvents

Material | Plastic  
 Size | 225 x 65 x 10mm  
 Finish | 603 - brown  
 605 - silver

| ITEM 1131

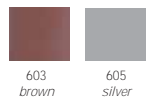

| RIH1186  
 | RIH1120

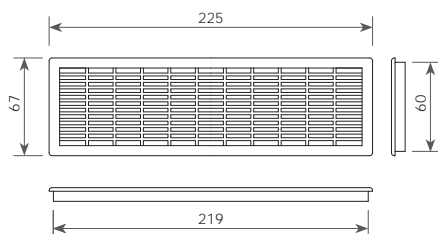



# Hardware

FOR OFFICE DESKING



## Connectors



**DESKTOP FLAT CONNECTOR** | ITEM 293

Material | ABS  
 Size | 160 x 16 x 50mm  
 Finish | black | RIH2153

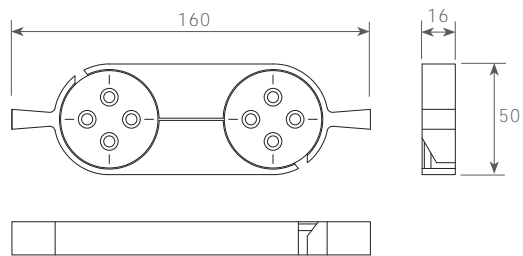

**FOLD AWAY HINGE** | ITEM 590

Material | plastic  
 Size | 50 x 40mm  
 Finish | black | RIH2180

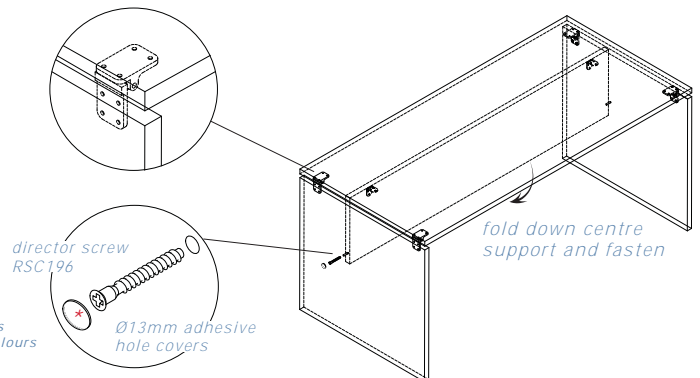
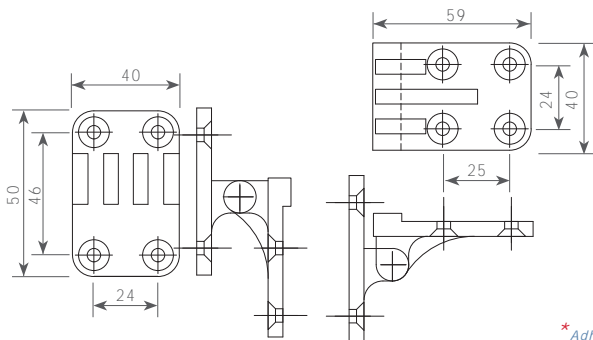
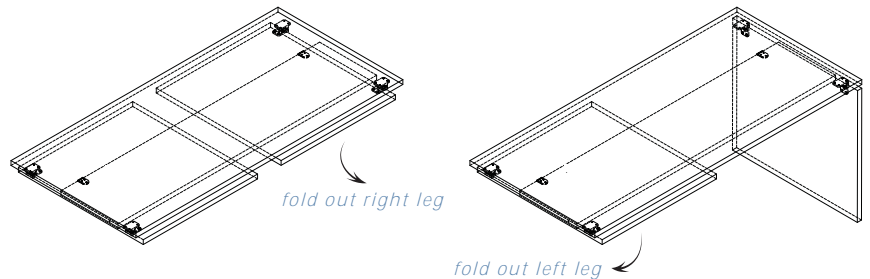

\* Adhesive hole covers available in various colours and in Ø13 & Ø20mm diameters

**MODESTY BLOCK** | ITEM 1391

Size | 30 x 10 x 10mm  
 Finish | white | RIH1291  
 | oak | RIH1299



**WEDGE FITTING** | ITEM 1280

Size | 48 x 28 x 14mm  
 Finish | black | RIH1178  
 | white | RIH1179  
 | cherry | RIH1181  
 | oak | RIH1182  
 | brown | RIH1183



# Fixing Brackets

## MOUNTING BRACKET | ITEM 805

Material | steel  
Finish | white | RIH686

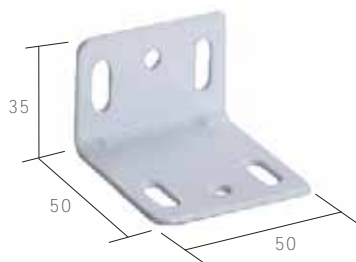

## L BRACKET | ITEM 803

Material | steel  
Finish | white | RIH687

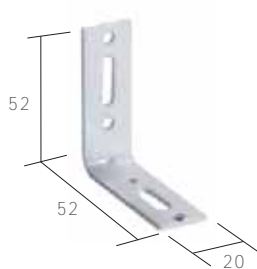

## SMALL MOUNTING BRACKET | ITEM 1557

Material | steel  
Finish | white epoxy | RIH1320



## FASCIA BRACKET | ITEM 801

Material | steel  
Finish | white | RIH685

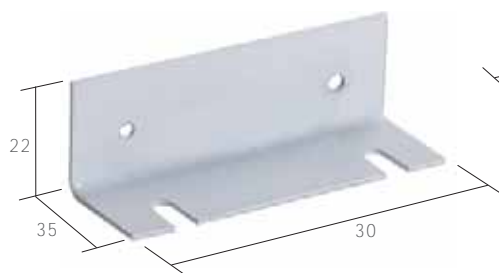

## FLAT PLATE | ITEM 1388

Material | steel  
Finish | white epoxy | RIH1286

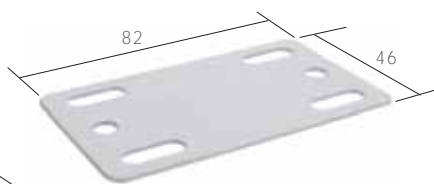

## HANGING PLATE | ITEM 1384

Material | steel  
Size | 62mm - 3 hole  
Finish | white | RIH1285



## FIXING PLATE | ITEM 1287

Material | steel  
Size | 40 x 50 x 1.6mm - 4 hole  
Finish | galvanised | RIH1234

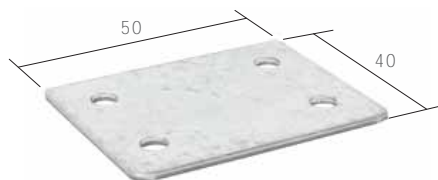

## SUPPORT BRACKET | ITEM 1802

Material | steel  
Size | 70 x 70 x 50mm  
Finish | black | RIH1627

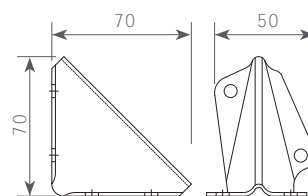

## CONNECTING SCREW | ITEM 906

Material | plastic  
Finish | white | RIH613

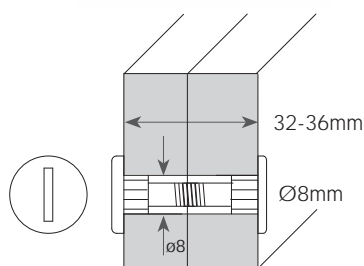

## CONNECTING SCREW | ITEM 678

Material | steel  
Finish | silver | RIH824

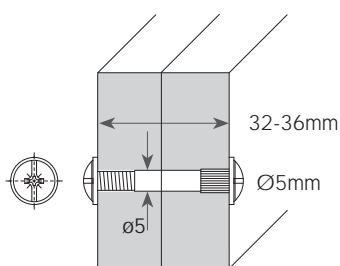

# Fixing Hardware

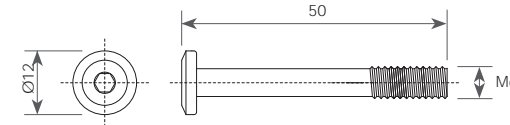
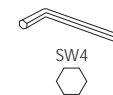



**MACHINE SCREW M6 x 50** | ITEM 1880  
 Material | metal  
 Size | M6 x 50mm | RIH1589





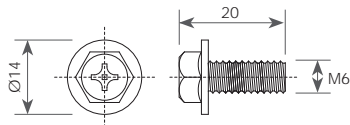
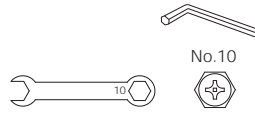

**MACHINE SCREW M6 x 10** | ITEM 1880  
 Material | metal  
 Size | M6 x 10mm | RIH1569  
 • Use with office desking

**BOLT FOR LEG M6 x 15** | ITEM 1880  
 Material | metal  
 Size | M6 x 15mm | RIH1835

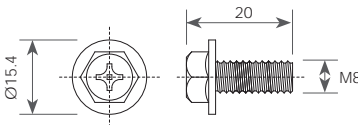
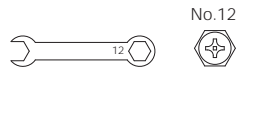

**BOLT FOR LEG M8 x 15** | ITEM 1880  
 Material | metal  
 Size | M8 x 15mm | RIH1836

**RUBBER NUTS M10 x 25** | ITEM 1801  
 Material | metal  
 Size | M10 x 25mm | RIH1621  
 • Drill Ø13mm hole  
 \*necked

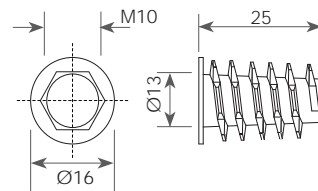
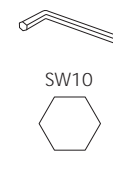
**RUBBER NUTS M8 x 20** | ITEM 1642  
 Material | metal  
 Size | M8 x 20mm | RIH1448  
 • Drill Ø11mm hole  
 \*\*full thread

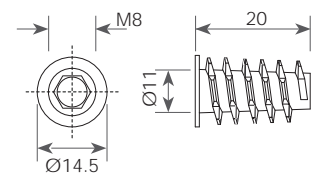
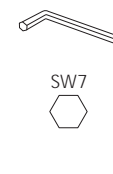
**RUBBER NUTS M8 x 13** | ITEM 1880  
 Material | metal  
 Size | M8 x 13mm | RIH1834  
 • Drill Ø10mm hole  
 \*necked

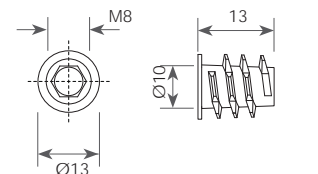
**RUBBER NUTS (2 SIZES)** | ITEM 1880  
 Material | metal  
 Size | M6 x 17mm \*\* | RIH1447  
 M6 x 20mm \* | RIH1445  
 • Drill Ø8mm hole  
 \*\*full thread / \*necked

**RUBBER NUTS M6 x 13** | ITEM 1641  
 Material | metal  
 Size | M6 x 13mm | RIH1453  
 • Drill Ø8.5mm hole  
 \*\*full thread

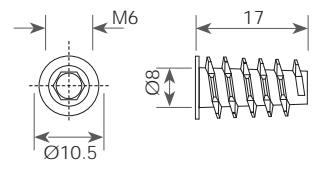
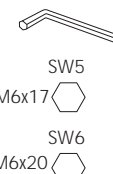
**RUBBER NUTS M6 x 10** | ITEM 1640  
 Material | metal  
 Size | M6 x 10mm | RIH1446  
 • Drill Ø8mm hole  
 \*\*full thread

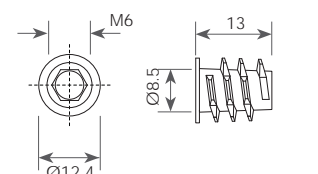
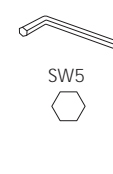

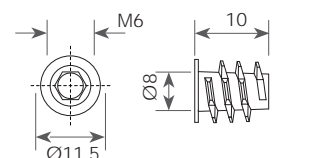
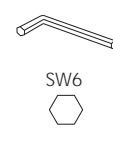
# Levelers

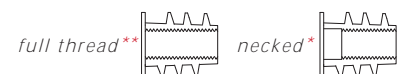

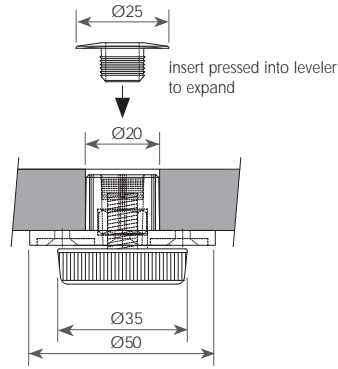
**EXPANDING BASE LEVELER** | ITEM 1806  
 Material | plastic and metal  
 Size | Ø50mm | RIH1619

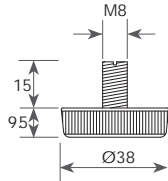

**M8 BASE LEVELER** | ITEM 1804  
 Material | plastic and metal  
 Size | Ø38mm | RIH1617

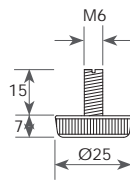

**M6 BASE LEVELER** | ITEM 1805  
 Material | plastic and metal  
 Size | Ø25mm | RIH1618

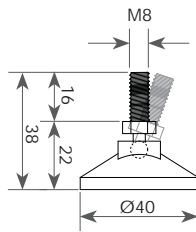

**M8 BASE LEVELER SWIVEL** | ITEM 1395  
 Material | plastic and metal  
 Size | Ø40mm | RIH1010

**BASE LEVELER M6 X Ø21mm** | ITEM 1666  
 Feature | including M6 insert  
 Material | plastic and metal  
 Size | Ø21mm | RIH1416

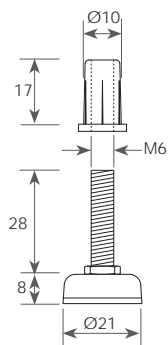

# Cupboard Glides

**CUPBOARD GLIDES** | ITEM 1338  
 Material | plastic  
 Code | Top Glide | RIH703  
 Bottom Glide | RIH704

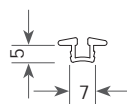
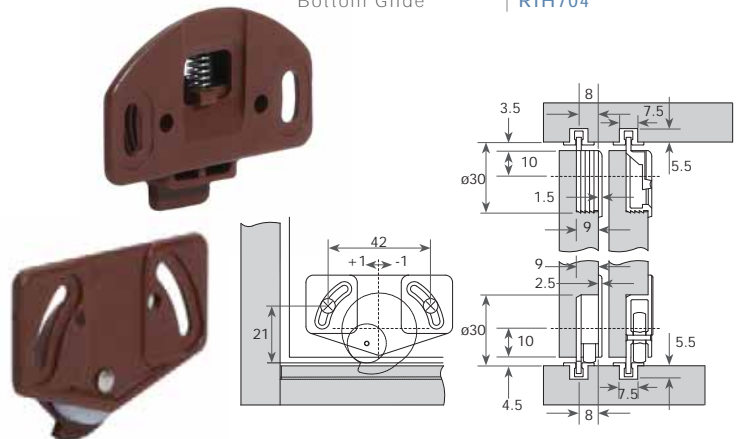

**TOP & BOTTOM TRACK** | ITEM 1338  
 Material | plastic  
 size | 3.35m  
 Code | Brown | RIH701  
 Oak | RIH702  
 White | RIH1246



# Finishes

## PRODUCT FINISHES FOR ALL HARDWARE AND ACCESSORIES

### METAL FINISHES

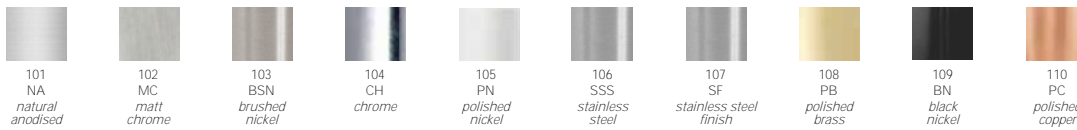

### ANTIQUE CLASSIC FINISHES



### RUSTIC WOOD FINISHES



### WOOD FINISHES

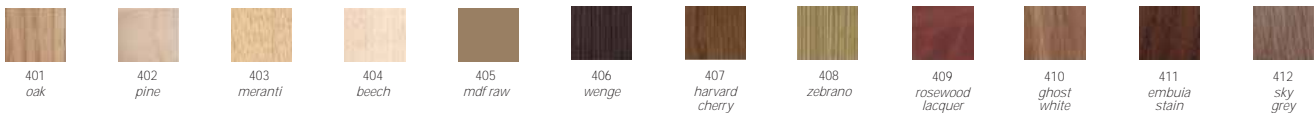

### POLYESTER FINISHES



### PLASTIC FINISHES

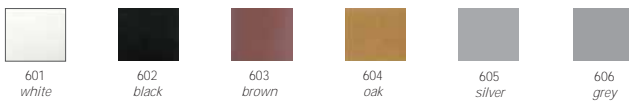

### CRYSTAL FINISHES

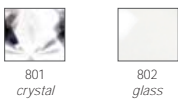

### POWDER COATED FINISHES: JOINERS

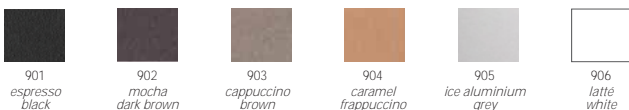

### POWDER COATED FINISHES: HANDLES

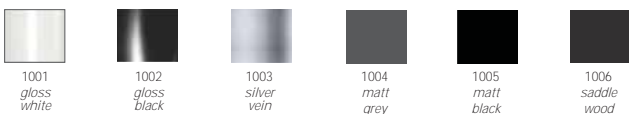

### POWDER COATED FINISHES: DESKS & LEGS





 **FFA**  
FITTINGS FOR AFRICA

*Hein*  
082 553 4502

**HANDLES - KNOBS - SINKS - MIXERS - HINGES**

21 Zune Street  
Magnavia  
Polokwane

Tel: 015 004 0198  
heloenterprises1@gmail.com