



**G\*GRASS®**

**TAVINEA SORTO**  
INTERIOR ACCESSORY SYSTEM

The new compact frame  
system for GRASS drawers.  
Simple. Attractive. Tidy.





## Perfect framework for the organisation of drawers

**Whether you opt for one, two or three elements – with the Tavinea Sorto frame system, drawers of any width can be organised simply and quickly.**

The frame elements are assembled from 6 mm narrow metal profiles, the shape of which creates Tavineo Sorto's functional good looks. Purist sleek design, matt surfaces, timeless colours – the understated elegance of the frame system looks equally good in drawers in the kitchen, bathroom, living room and bedroom. The system's innovative corner connection is both spacer and anti-slip device.

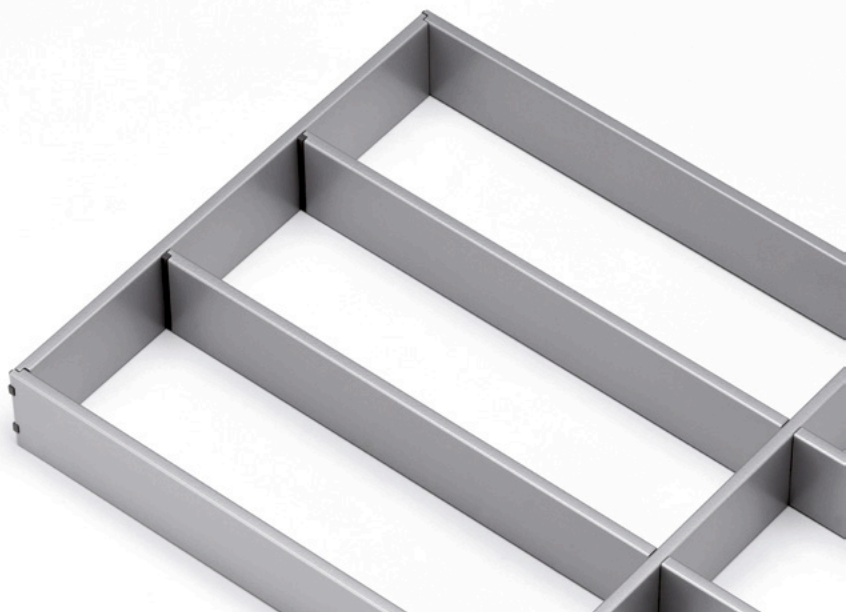

Knife block, foil holder or spice rack – with the appropriate additions, Tavinea Sorto becomes a comprehensive interior accessory system.

## TAVINEA SORTO INTERIOR ACCESSORY SYSTEM

Tavinea Sorto appeals with its purist design and straightforward system, which couldn't be simpler. The perfect partner for all GRASS drawer systems.



Whether Nova Pro, DWD XP or Vionaro – Tavinea Sorto is the ideal complement for all GRASS drawer systems. Material, shape, colour and surface are not just similar, but identical. To be precise – they are made of the same steel and coated with the same powder. This means that the interior accessory system harmoniously matches the colour of the drawer sides and, in combination, reveals its fascinating effect.

**GRASS drawer systems and Tavinea Sorto.  
Two that are really one.**

A spring device on the inside of the divider rail makes it possible to position the narrow longitudinal divider where needed. In that way, a single divider rail can be used to create two compartments or to hold accessories such as a knife block, foil holder or spice rack firmly in place.





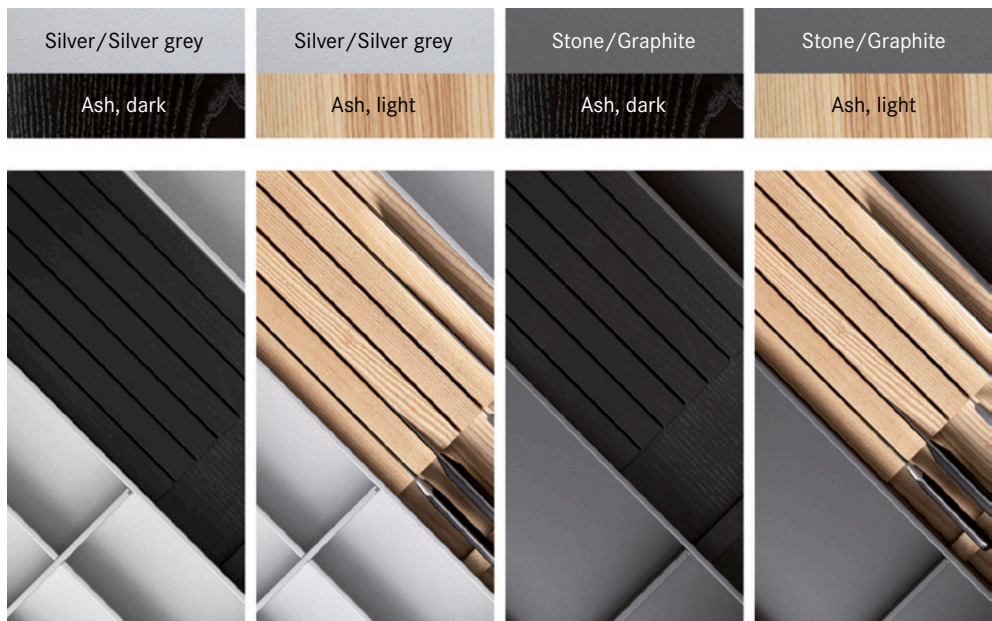

Now everything is  
where it should be.

The high-quality frame elements made of steel and the accessory parts made of wood organise the storage space of drawers in a particularly attractive way. The light-coloured wood combines especially well with dark colour shades, while dark ash is better suited to the silvery metal colours. Irrespective of the wood colour you choose, the combination of metal and wood means that Tavinea Sorto always has a dynamic and lively feel.

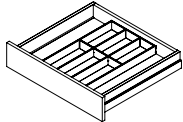

# TAVINEA SORTO

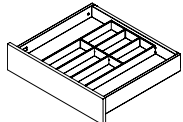
Perfect framework using the compact interior accessory system for drawers.

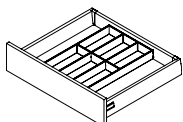
	Product description		Page
	<b>Tavinea Sorto for Nova Pro Scala</b> <ul style="list-style-type: none"><li>• Modular interior accessory system</li><li>• Perfect organisation for drawers with cutlery and small items</li><li>• High-quality frames and divider rails made of powder-coated steel</li></ul>		6
	<b>Tavinea Sorto for Vionaro</b> <ul style="list-style-type: none"><li>• Modular interior accessory system</li><li>• Perfect organisation for drawers with cutlery and small items</li><li>• High-quality frames and divider rails made of powder-coated steel</li></ul>		12
	<b>Tavinea Sorto for DWD XP</b> <ul style="list-style-type: none"><li>• Modular interior accessory system</li><li>• Perfect organisation for drawers with cutlery and small items</li><li>• High-quality frames and divider rails made of powder-coated steel</li></ul>		18

# TAVINEA SORTO FOR NOVA PRO

Interior accessory system



- Perfect organisation for cutlery and small items
- High-quality frames and divider rails made of powder-coated steel
- Colour-coordinated
- Innovative anti-slip device ensures firm seating on the base panel

**Packaging unit (PU):**

201 = 1 unit in a cardboard box  
207 = 10 units in a cardboard box

**Notes:**

- Tavinea Sorto B186 can be used with cabinet widths from 300
- Tavinea Sorto B276 can be used with cabinet widths from 400

## ORDER INFORMATION

**1 Tavinea Sorto B186**  
Single item



NL	Stone			Silver								
	Art.-no.	PU		Art.-no.	PU							
350	F007130074	201		F007130075	201							
400	F007130078	201		F007130079	201							
450	F007130082	201		F007130083	201							
500	F007130086	201		F007130087	201							
550	F007130090	201		F007130091	201							
600	F007130094	201		F007130095	201							
650	F007130098	201		F007130099	201							

**2 Tavinea Sorto B276**  
Single item



NL	Stone			Silver								
	Art.-no.	PU		Art.-no.	PU							
400	F007130050	201		F007130051	201							
450	F007130054	201		F007130055	201							
500	F007130058	201		F007130059	201							
550	F007130062	201		F007130063	201							
600	F007130066	201		F007130067	201							
650	F007130070	201		F007130071	201							

**3 Tavinea Sorto divider rail**  
Single item



NL	Stone			Silver								
	Art.-no.	PU		Art.-no.	PU							
350	F007130102	207		F007130103	207							
400	F007130106	207		F007130107	207							
450	F007130110	207		F007130111	207							
500	F007130114	207		F007130115	207							
550	F007130118	207		F007130119	207							
600	F007130122	207		F007130123	207							
650	F007130126	207		F007130127	207							

## PAGE REFERENCES

Accessories	8
Installation information	10



**1 Tavinea Sorto B186**



NL 350



NL 400 - 500



NL 550 - 650

**2 Tavinea Sorto B276**



NL 400



NL 450 - 500



NL 550 - 650

**3 Tavinea Sorto divider rail**



Tavinea Sorto accessories see page 8

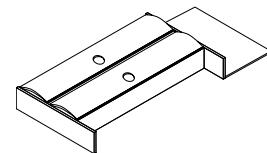
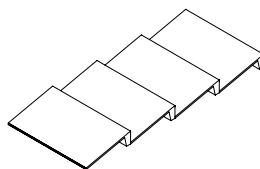
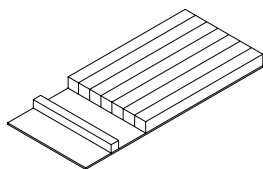

**LEGEND**

B Width  
KB Cabinet width  
NL Nominal length

# TAVINEA SORTO FOR NOVA PRO

## Accessories

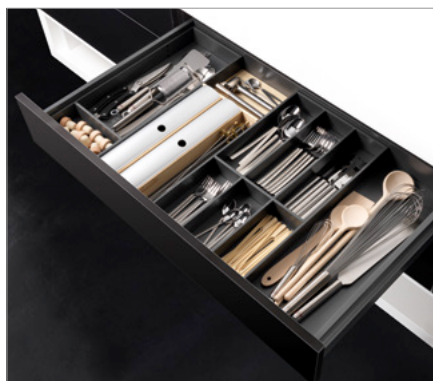

- The right accessories for all requirements
- Knives, spice jars, cooking foil, cutlery or Eau de Toilette – with Tavinea Sorto accessories, everything has its perfect place
- High-quality materials: Aluminium and solid wood

### Packaging unit (PU):

201 = 1 unit in a cardboard box

### Note:

Accessories are hygiene-tested and non-toxic

## ORDER INFORMATION

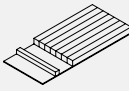
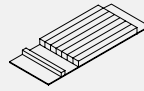
1 Knife block Single item						
	NL 450	PU	NL 500	PU	NL 550 <sup>1</sup>	PU
Light ash	F007108657	201	F007101990	201	F007101990 F007108659	201
Dark ash	F007108658	201	F007101995	201	F007101995 F007108660	201

<sup>1</sup> NL 550 comprises a knife block and levelling element. Please order both article numbers.

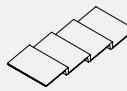
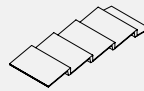
2 Spice rack Single item				
	NL 500	PU	NL 550 <sup>1</sup>	PU
Light ash	F007101992	201	F007101992 F007108659	201
Dark ash	F007101997	201	F007101997 F007108660	201

<sup>1</sup> NL 550 comprises a spice rack and levelling element. Please order both article numbers.

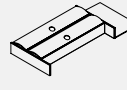
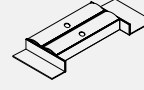
3 Foil holder Single item				
	NL 500	PU	NL 550 <sup>1</sup>	PU
Light ash	F007101994	201	F007101994 F007108659	201
Dark ash	F007101999	201	F007101999 F007108660	201

<sup>1</sup> NL 550 comprises a foil holder and levelling element. Please order both article numbers.

## PAGE REFERENCES

Tavinea Sorto	6
Installation information	10



1 Knife block



2 Spice rack

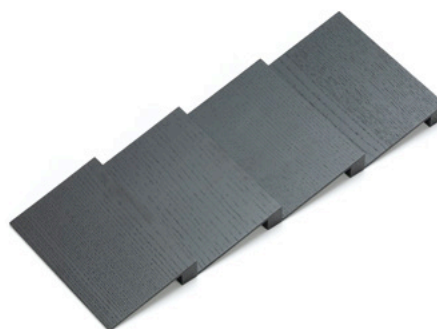

3 Foil holder



LEGEND

NL Nominal length

# TAVINEA SORTO FOR NOVA PRO

## Installation information

### APPLICATION EXAMPLES

KB 450

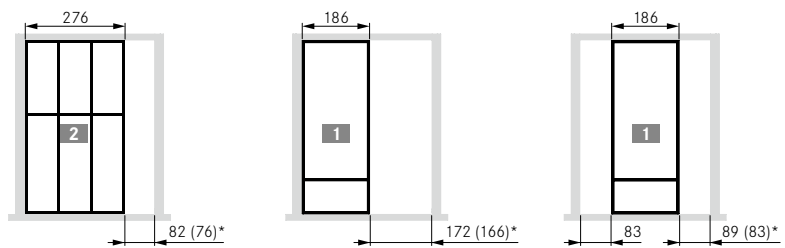
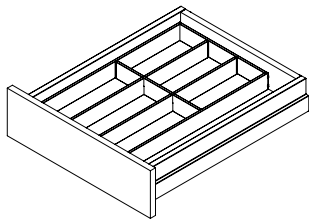

KB 600

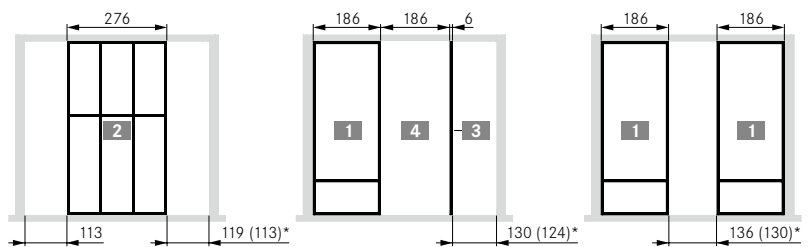
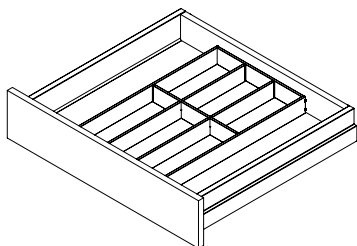

KB 900

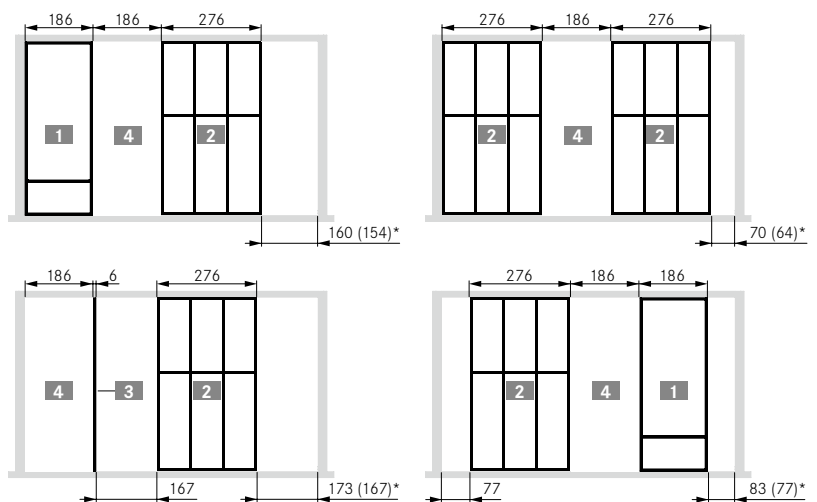
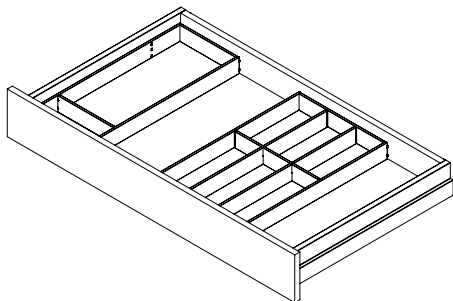

KB 1200

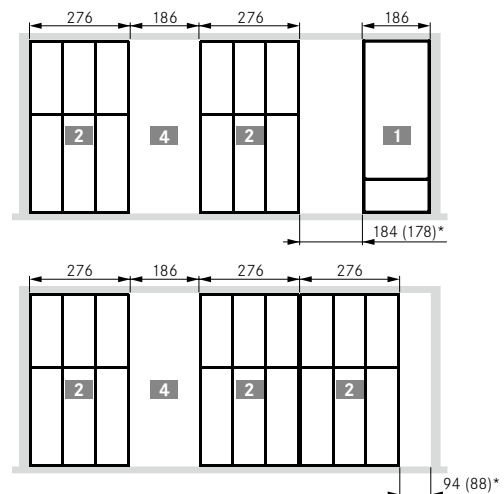
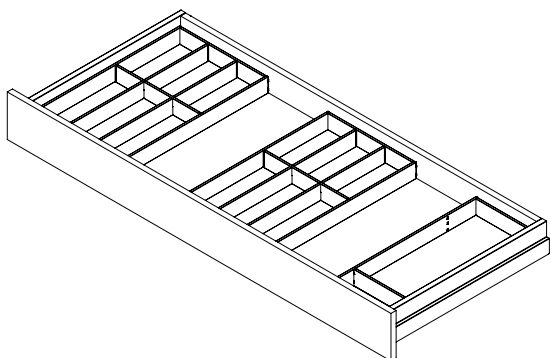

\* S16 (S18/S19)

APPLICATION EXAMPLE

**Description**

**1**

**2**

**3**

**4**

NL	X
350	329
400	379
450	429
500	479
550	530
600	580
650	630

INSTALLATION INFORMATION

**Description**

S/EB	External cabinet width (KB)									
	300	400	500	600	700	800	900	1000	1100	1200
16/29	208	308	408	508	608	708	808	908	1008	1108
18/30	202	302	402	502	602	702	802	902	1002	1102
19/29	202	302	402	502	602	702	802	902	1002	1102
Internal dimension (LWS)										

LEGEND

EB Construction width  
KB Cabinet width  
LWS Clear drawer width  
NL Nominal length

S Cabinet side wall  
TAG Tolerance compensation

# TAVINEA SORTO FOR VIONARO

Interior accessory system



- Perfect organisation for cutlery and small items
- High-quality frames and divider rails made of powder-coated steel
- Colour-coordinated
- Innovative anti-slip device ensures firm seating on the base panel

**Packaging unit (PU):**

201 = 1 unit in a cardboard box  
207 = 10 units in a cardboard box

**Notes:**

- Tavinea Sorto B186 can be used with cabinet widths from 300
- Tavinea Sorto B276 can be used with cabinet widths from 400

## ORDER INFORMATION

1 Tavinea Sorto B186 Single item												
NL	Silver grey				Graphite							
	Art.-no.	PU			Art.-no.	PU						
350	F007130148	201			F007130149	201						
400	F007130151	201			F007130152	201						
450	F007130154	201			F007130155	201						
500	F007130157	201			F007130158	201						
550	F007130160	201			F007130161	201						
600	F007130163	201			F007130164	201						
650	F007130166	201			F007130167	201						

2 Tavinea Sorto B276 Single item												
NL	Silver grey				Graphite							
	Art.-no.	PU			Art.-no.	PU						
400	F007130130	201			F007130131	201						
450	F007130133	201			F007130134	201						
500	F007130136	201			F007130137	201						
550	F007130139	201			F007130140	201						
600	F007130142	201			F007130143	201						
650	F007130145	201			F007130146	201						

3 Tavinea Sorto divider rail Single item												
NL	Silver grey				Graphite							
	Art.-no.	PU			Art.-no.	PU						
350	F007130169	207			F007130170	207						
400	F007130172	207			F007130173	207						
450	F007130175	207			F007130176	207						
500	F007130178	207			F007130179	207						
550	F007130181	207			F007130182	207						
600	F007130184	207			F007130185	207						
650	F007130187	207			F007130188	207						

## PAGE REFERENCES

Accessories	14		
Installation information	16		

**1 Tavinea Sorto B186**



NL 350



NL 400 - 500



NL 550 - 650

**2 Tavinea Sorto B276**



NL 400

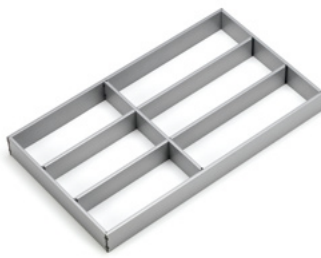

NL 450 - 500



NL 550 - 650

**3 Tavinea Sorto divider rail**



Tavinea Sorto accessories see page 14

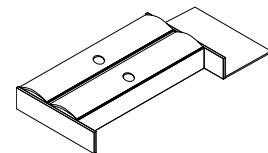
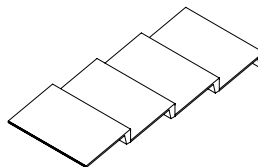
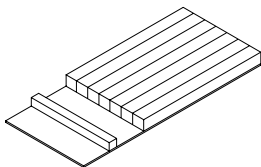

**LEGEND**

B Width  
KB Cabinet width  
NL Nominal length

# TAVINEA SORTO FOR VIONARO

## Accessories

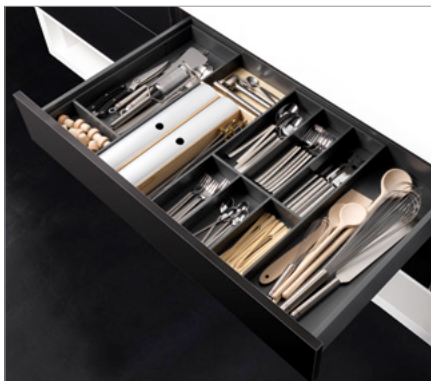

- The right accessories for all requirements
- Knives, spice jars, cooking foil, cutlery or Eau de Toilette – with Tavinea Sorto accessories, everything has its perfect place
- High-quality materials: Aluminium and solid wood

### Packaging unit (PU):

201 = 1 unit in a cardboard box

### Note:

Accessories are hygiene-tested and non-toxic

## ORDER INFORMATION

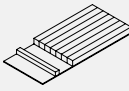
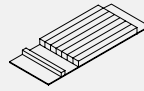
1 Knife block Single item						
	NL 450	PU	NL 500	PU	NL 550 <sup>1</sup>	PU
Light ash	F007108661	201	F007102418	201	F007102418 F007108659	201
Dark ash	F007108662	201	F007102424	201	F007102424 F007108660	201

<sup>1</sup> NL 550 comprises a knife block and levelling element. Please order both article numbers.

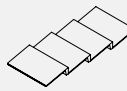
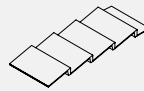
2 Spice rack Single item				
	NL 500	PU	NL 550 <sup>1</sup>	PU
Light ash	F007102420	201	F007102420 F007108659	201
Dark ash	F007102426	201	F007102426 F007108660	201

<sup>1</sup> NL 550 comprises a spice rack and levelling element. Please order both article numbers.

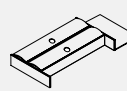
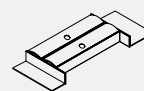
3 Foil holder Single item				
	NL 500	PU	NL 550 <sup>1</sup>	PU
Light ash	F007102422	201	F007102422 F007108659	201
Dark ash	F007102428	201	F007102428 F007108660	201

<sup>1</sup> NL 550 comprises a foil holder and levelling element. Please order both article numbers.

## PAGE REFERENCES

Tavinea Sorto	12
Installation information	16

1 Knife block



2 Spice rack

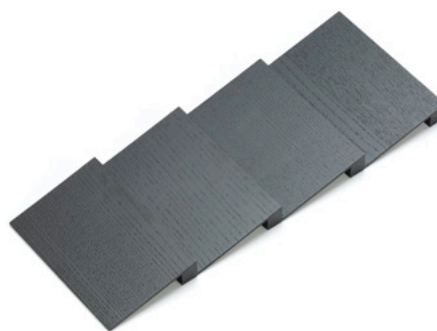

3 Foil holder



LEGEND

NL Nominal length

# TAVINEA SORTO FOR VIONARO

Installation information

## APPLICATION EXAMPLES

KB 450

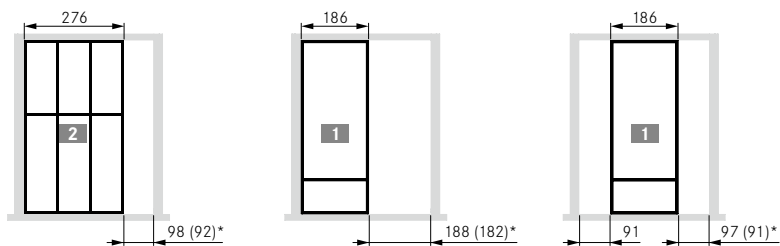
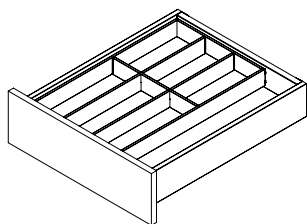

KB 600

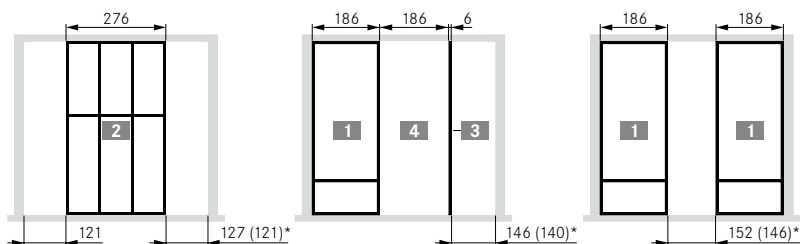
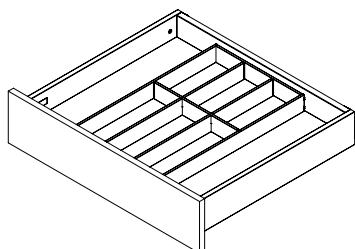

KB 900

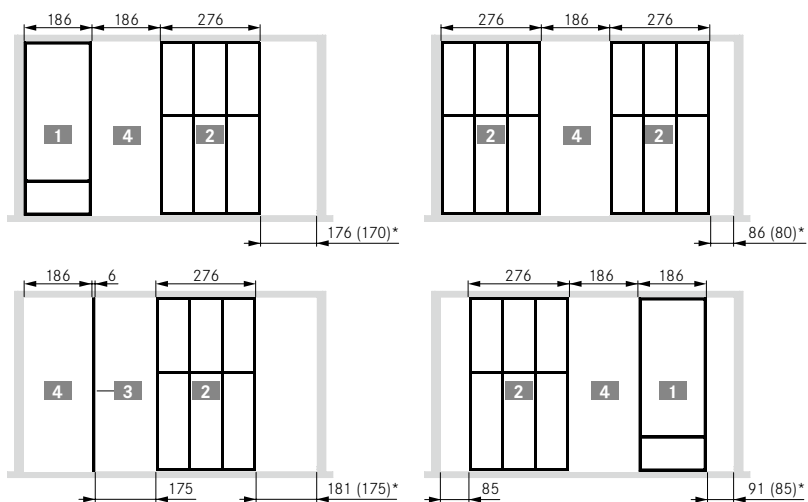
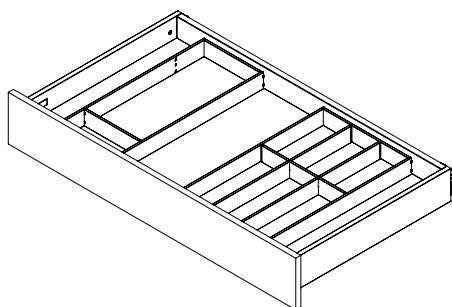

KB 1200

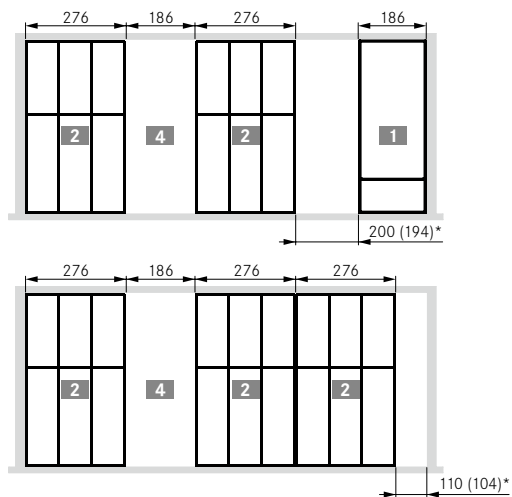
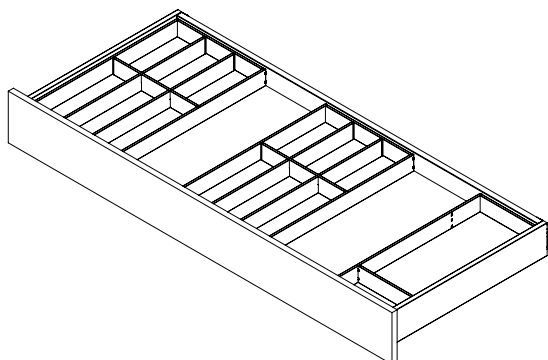

\* S16 (S19)



APPLICATION EXAMPLE

**Description**

**1**

**2**

**3**

**4**

NL	X
350	322
400	372
450	422
500	472
550	523
600	573
650	623

INSTALLATION INFORMATION

**Description**

S	External cabinet width (KB)									
	300	400	500	600	700	800	900	1000	1100	1200
16	224	324	424	524	624	724	824	924	1024	1124
18	220	320	420	520	620	720	820	920	1020	1120
19	218	318	418	518	618	718	818	918	1018	1118
Internal dimension (LWS)										

LEGEND

<b>KB</b> Cabinet width	<b>TAG</b> Tolerance compensation	
<b>LWS</b> Clear drawer width		
<b>NL</b> Nominal length		
<b>S</b> Cabinet side wall		

# TAVINEA SORTO FOR DWD XP

Interior accessory system



- Perfect organisation for cutlery and small items
- High-quality frames and divider rails made of powder-coated steel
- Innovative anti-slip device ensures firm seating on the base panel

**Packaging unit (PU):**

201 = 1 unit in a cardboard box  
207 = 10 units in a cardboard box

**Notes:**

- Tavinea Sorto B186 can be used with cabinet widths from 300
- Tavinea Sorto B276 can be used with cabinet widths from 400

## ORDER INFORMATION

1 Tavinea Sorto B186 Single item									
NL	Silver grey			Graphite					
	Art.-no.	PU		Art.-no.	PU				
350	F007130148	201		F007130149	201				
400	F007130151	201		F007130152	201				
450	F007130154	201		F007130155	201				
500	F007130157	201		F007130158	201				
550	F007130160	201		F007130161	201				
600	F007130163	201		F007130164	201				
650	F007130166	201		F007130167	201				

2 Tavinea Sorto B276 Single item									
NL	Silver grey			Graphite					
	Art.-no.	PU		Art.-no.	PU				
400	F007130130	201		F007130131	201				
450	F007130133	201		F007130134	201				
500	F007130136	201		F007130137	201				
550	F007130139	201		F007130140	201				
600	F007130142	201		F007130143	201				
650	F007130145	201		F007130146	201				

3 Tavinea Sorto divider rail Single item									
NL	Silver grey			Graphite					
	Art.-no.	PU		Art.-no.	PU				
350	F007130169	207		F007130170	207				
400	F007130172	207		F007130173	207				
450	F007130175	207		F007130176	207				
500	F007130178	207		F007130179	207				
550	F007130181	207		F007130182	207				
600	F007130184	207		F007130185	207				
650	F007130187	207		F007130188	207				

## PAGE REFERENCES

Accessories	20
Installation information	22

**1 Tavinea Sorto B186**



NL 350



NL 400 - 500



NL 550 - 650

**2 Tavinea Sorto B276**



NL 400



NL 450 - 500



NL 550 - 650

**3 Tavinea Sorto divider rail**



Tavinea Sorto accessories see page 20

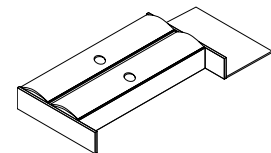
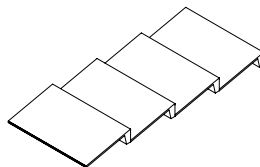
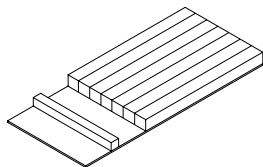

**LEGEND**

B Width  
KB Cabinet width  
NL Nominal length

# TAVINEA SORTO FOR DWD XP

## Accessories



- The right accessories for all requirements
- Knives, spice jars, cooking foil, cutlery or Eau de Toilette – with Tavinea Sorto accessories, everything has its perfect place
- High-quality materials: Aluminium and solid wood

### Packaging unit (PU):

201 = 1 unit in a cardboard box

### Note:

Accessories are hygiene-tested and non-toxic

## ORDER INFORMATION

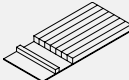
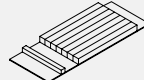
1 Knife block Single item						
	NL 450	PU	NL 500	PU	NL 550 <sup>1</sup>	PU
Light ash	F007108661	201	F007102418	201	F007102418	201
Dark ash	F007108662	201	F007102424	201	F007102424	201
					F007108659	
					F007108660	

<sup>1</sup> NL 550 comprises a knife block and levelling element. Please order both article numbers.

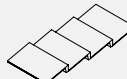
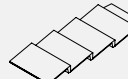
2 Spice rack Single item				
	NL 500	PU	NL 550 <sup>1</sup>	PU
Light ash	F007102420	201	F007102420	201
Dark ash	F007102426	201	F007102426	201
			F007108659	
			F007108660	

<sup>1</sup> NL 550 comprises a spice rack and levelling element. Please order both article numbers.

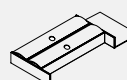
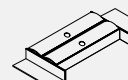
3 Foil holder Single item				
	NL 500	PU	NL 550 <sup>1</sup>	PU
Light ash	F007102422	201	F007102422	201
Dark ash	F007102428	201	F007102428	201
			F007108659	
			F007108660	

<sup>1</sup> NL 550 comprises a foil holder and levelling element. Please order both article numbers.

## PAGE REFERENCES

Tavinea Sorto	18
Installation information	22

1 Knife block



2 Spice rack

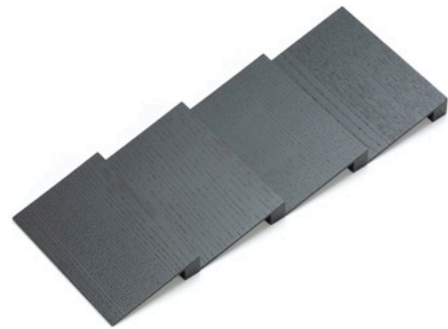

3 Foil holder



LEGEND

NL Nominal length

# TAVINEA SORTO FOR DWD XP

## Installation information

### APPLICATION EXAMPLES

#### KB 450

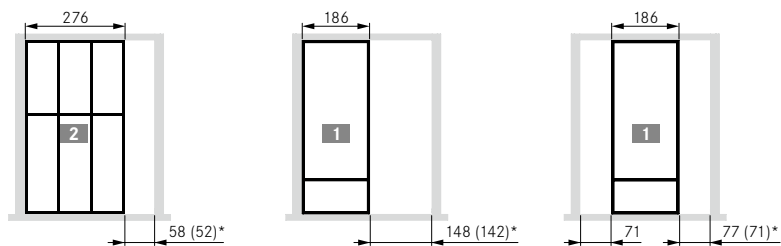
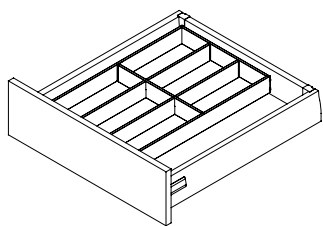

#### KB 600

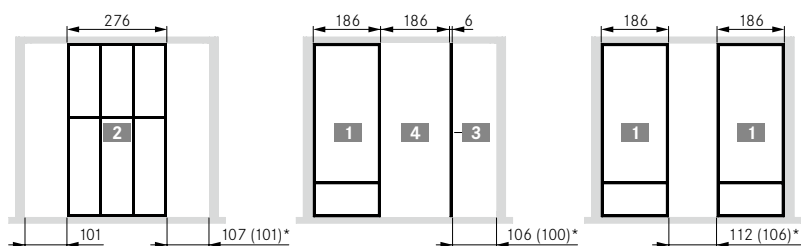
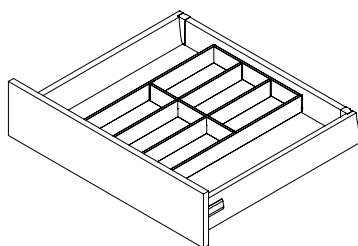

#### KB 900

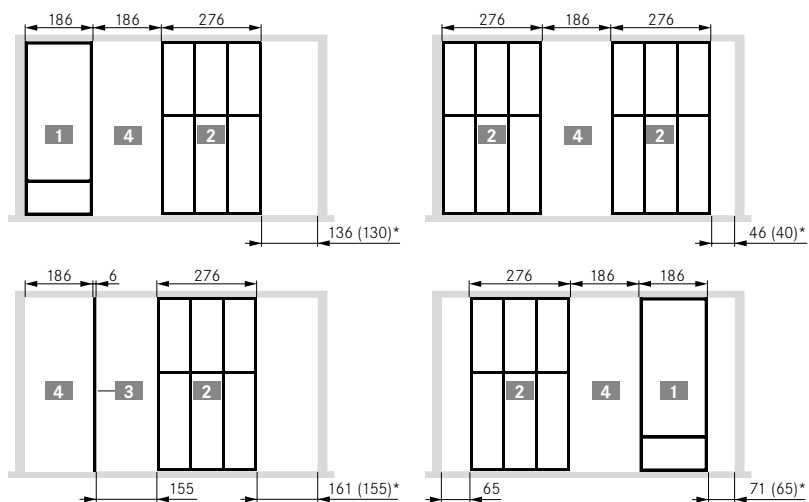
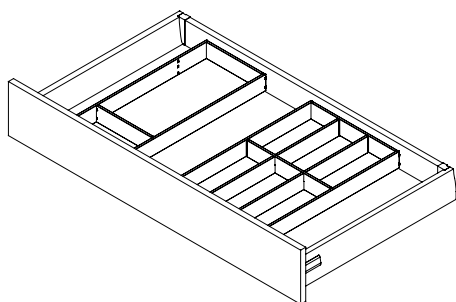

#### KB 1200

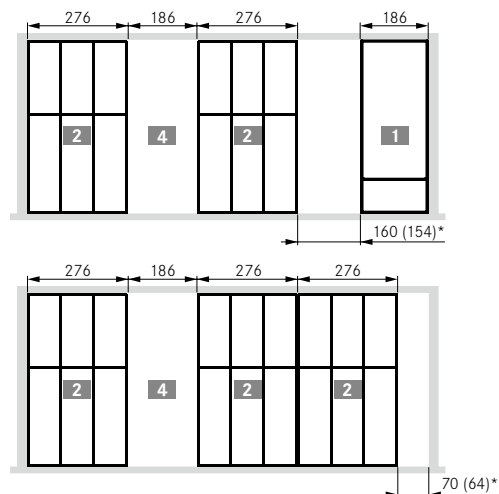
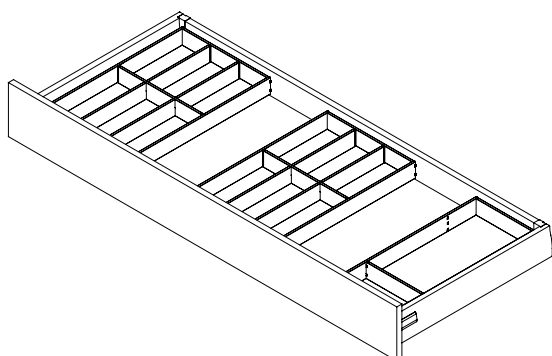

\* S16 (S19)

APPLICATION EXAMPLE

**Description**

**1**

**2**

**3**

**4**

NL	X
350	322
400	372
450	422
500	472
550	523
600	573
650	623

INSTALLATION INFORMATION

**Description**

S	External cabinet width (KB)									
	300	400	500	600	700	800	900	1000	1100	1200
16	184	284	384	484	584	684	784	884	984	1084
18	180	280	380	480	580	680	780	880	980	1080
19	178	278	378	478	578	678	778	878	978	1078
Internal dimension (LWS)										

LEGEND

<b>KB</b>	Cabinet width	<b>TAG</b>	Tolerance compensation
<b>LWS</b>	Clear drawer width		
<b>NL</b>	Nominal length		
<b>S</b>	Cabinet side wall		

# G\*GRASS®

GRASS GmbH  
Movement Systems  
Grass Platz 1  
6973 Höchst, Austria  
T +43 5578 701-0  
F +43 5578 701-59  
info@grass.eu



[www.grass.eu](http://www.grass.eu)



**FFA**  
FITTINGS FOR AFRICA

*Hein*  
082 553 4502

**HANDLES - KNOBS - SINKS - MIXERS - HINGES**

21 Zune Street  
Magnavia  
Polokwane

Tel: 015 004 0198  
heloenterprises1@gmail.com

Status: 05/2019

The latest version of the catalogue  
is available on our website.